

User's Guide

Samsung Printer *Xpress*

C43x series

C43xW series

BASIC

This guide provides information concerning the installation, basic operation and troubleshooting on windows.

ADVANCED

This guide provides information about the installation, advanced configuration, operation and troubleshooting on various OS environments.

Some features may not be available depending on models or countries.

BASIC



1. Introduction

Key benefits	4
Features by model	6
Useful to know	9
About this user's guide	10
Safety information	11
Machine overview	17
Control panel overview	20
Turning on the machine	22
Installing the driver locally	23
Reinstalling the driver	25



2. Learning the Basic Usage

Media and tray	27
Basic printing	36



3. Maintenance

Ordering supplies and accessories	42
Available supplies	43

Available maintenance parts	44
Storing the toner cartridge	45
Redistributing toner	47
Replacing the toner cartridge	49
Replacing the waste toner container	51
Replacing the imaging unit	53
Cleaning the machine	55
Tips for moving & storing your machine	57



4. Troubleshooting

Tips for avoiding paper jams	59
Clearing paper jams	60
Understanding the status LED	63



5. Appendix

Specifications	68
Regulatory information	77
Copyright	88



1. Introduction

This chapter provides information you need to know before using the machine.

- **Key benefits** 4
- **Features by model** 6
- **Useful to know** 9
- **About this user's guide** 10
- **Safety information** 11
- **Machine overview** 17
- **Control panel overview** 20
- **Turning on the machine** 22
- **Installing the driver locally** 23
- **Reinstalling the driver** 25

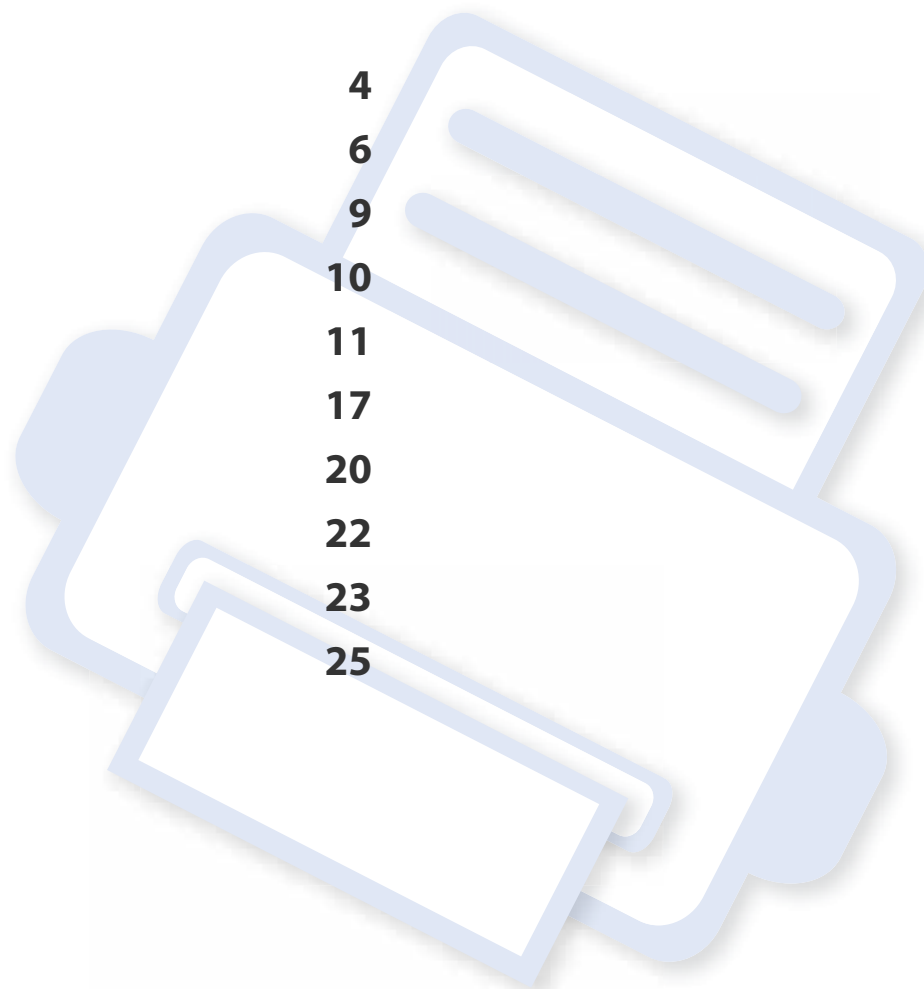

Key benefits

Environmentally friendly



- To save toner and paper, this machine supports the Eco feature (see "Easy Eco Driver" on page 157).
- To save paper, you can print multiple pages on a single sheet of paper (see "Using advanced print features" on page 142).
- To save paper, you can print on both sides of the paper (manual double-sided printing) (see "Using advanced print features" on page 142).
- To save electricity, this machine automatically conserves electricity by substantially reducing power consumption when not in use.
- We recommend using recycled paper for saving energy.

Fast high resolution printing



- You can print in a full range of colors using cyan, magenta, yellow, and black.
- You can print with a resolution of up to 2,400 x 600 dpi effective output (600 x 600 x 2 bit).
- Fast, on-demand printing.

Convenience



- Simply touch your cell phone on the NFC tag on your printer and get the print job done (see "Using the NFC feature" on page 127).
- You can print on the go from your smartphone or computer using Samsung Cloud Print apps (see "Samsung Cloud Print" on page 134).
- You can print on the go from your smartphone or computer using Google Cloud Print enabled apps (see "Google Cloud Print™" on page 136).
- Easy Capture Manager allows you to easily edit and print whatever you captured using the Print Screen key on the keyboard (see "Easy Capture Manager" on page 155).
- Samsung Easy Printer Manager and Samsung Printer Status are a program that monitors and informs you of the machine's status and allows you to customize the machine's settings (see "Using Samsung Easy Printer Manager" on page 164 or "Using Samsung Printer Status" on page 166).
- Smart Update allows you to check for the latest software and install the latest version during the printer driver installation process. This is available only for Windows OS users.
- If you have Internet access, you can get help, support application, machine drivers, manuals, and order information from the Samsung website, www.samsung.com > find your product > Support or Downloads.

Key benefits

Wide range of functionality and application support



- Supports various paper sizes (see "Print media specifications" on page 70).
- Print watermark: You can customize your documents with words, such as "**CONFIDENTIAL**" (see "Using advanced print features" on page 142).
- Print posters: The text and pictures of each page of your document are magnified and printed across the multiple sheets of paper and can then be taped together to form a poster (see "Using advanced print features" on page 142).
- You can print in various operating systems (see "System requirements" on page 73).
- Your machine is equipped with a USB interface and/or a network interface.

Supports various wireless network setting method



- Using the WPS (Wi-Fi Protected Setup™) button
 - You can easily connect to a wireless network using the WPS button on the machine and the access point (a wireless router).

- Using the USB cable or a network cable
 - You can connect and set various wireless network settings using a USB cable or a network cable.
- Using the Wi-Fi Direct
 - You can conveniently print from your mobile device using the Wi-Fi or Wi-Fi Direct feature.



See "Introducing wireless set up methods" on page 109.

Features by model

Some features and optional goods may not be available depending on model or country.

Operating System

Operating System	C43x series	C43xW series
Windows	•	•
Mac	•	•
Linux	•	•

(•: Supported)

Features by model

Software



You can install the printer driver and software when you insert the software CD into your CD-ROM drive.

For Windows, select the printer driver and software in the **Select Software to Install** window.

Software	C43x series	C43xW series
SPL printer driver	●	●
XPS printer driver ^a	●	●
Samsung Easy Color Manager ^a	●	●
Samsung Easy Printer Manager	●	●
Samsung Printer Center	●	●
Samsung Printer Status	●	●
Eco Driver Pack ^b	●	●
Samsung Stylish Driver Pack ^c	●	●
SyncThru™ Web Service		●

a. Download the software from the Samsung website and install it: (<http://www.samsung.com> > find your product > Support or Downloads). Before installing, check whether your computer's OS support the software.

b. To use the Easy Eco Driver features, the Eco Driver Pack must be installed.

c. The printer driver includes a user interface that is optimized for touchscreens. To use this UI, click **Samsung Printer Center** > **Device Options** and then select **Stylish User Interface** (see "Using Samsung Printer Center" on page 158).

(●: Supported, Blank: Not supported)

Features by model

Variety feature

Features	C43x series	C43xW series
Hi-Speed USB 2.0	●	●
Network Interface Ethernet 10/100 Base TX wired LAN		●
Network Interface 802.11b/g/n wireless LAN ^a		●
IPv6		●
NFC (Near Field Communication) printing		●
Mopria™		●
Samsung Mobile Print		●
Samaung Cloud Print		●
Google Cloud Print™		●
Wi-Fi Protected Setup™ (WPS)		●
Eco printing (Easy Eco Driver) ^b	●	●
Manual duplex (2-sided) printing ^c	●	●

a. Depending on your country, wireless LAN card may not be available. For some countries, only 802.11 b/g can be applied. Contact your local Samsung dealer or the retailer where you bought your machine.

b. Setting the ECO settings is available from the windows driver.

c. Available for Windows OS users only.

(●: Supported, Blank: Not supported)

Useful to know



Where can I download the machine's driver?

- Visit www.samsung.com/printer to download the latest machine's driver, and install it on your system.



Where can I purchase accessories or supplies?

- Inquire at a Samsung distributor or your retailer.
- Visit www.samsung.com/supplies. Select your country/region to view product service information.



The status LED flashes or remains constantly on.

- Turn the product off and on again.
- Check the meanings of LED indications in this manual and troubleshoot accordingly (see "Understanding the status LED" on page 63).



A paper jam has occurred.

- Open and close the cover (see "Front view" on page 18).
- Check the instructions on removing jammed paper in this manual and troubleshoot accordingly (see "Clearing paper jams" on page 60).



Printouts are blurry.

- The toner level might be low or uneven. Shake the toner cartridge.
- Try a different print quality setting.
- Replace the toner cartridge.



The machine does not print.

- Open the print queue list and remove the document from the list (see "Canceling a print job" on page 37).
- Remove the driver and install it again (see "Installing the driver locally" on page 23).
- Select your machine as your default machine in your Windows.

About this user's guide

This user's guide provides information for your basic understanding of the machine as well as detailed steps to explain machine usage.



- Do not discard this manual, and keep it for future reference.
- Read the safety information before using the machine.
- If you have a problem using the machine, refer to the troubleshooting chapter.
- Terms used in this user's guide are explained in the glossary chapter.
- All illustrations in this user's guide may differ from your machine depending on its options or model you purchased.
- The screenshots in this user's guide may differ from your machine depending on the machine's firmware/driver version.
- The procedures in this user's guide are mainly based on Windows 7.

Conventions

Some terms in this guide are used interchangeably, as below:

- Document is synonymous with original.
- Paper is synonymous with media, or print media.
- Machine refers to printer or MFP.

General icons



Icon	Text	Description
	Caution	Gives users information to protect the machine from possible mechanical damage or malfunction.
	Warning	Used to alert users to the possibility of personal injury.
	Note	Provides additional information or detailed specification of the machine function and feature.

Safety information

These warnings and precautions are included to prevent injury to you and others, and to prevent any potential damage to your machine. Be sure to read and understand all of these instructions before using the machine. After reading this section, keep it in a safe place for future reference.





Important safety symbols

Explanation of all icons and signs used in this chapter

	Warning	Hazards or unsafe practices that may result in severe personal injury or death.
	Caution	Hazards or unsafe practices that may result in minor personal injury or property damage.
		Do not attempt.



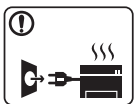



Operating environment

Warning

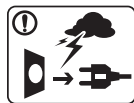
	<p>Do not use if the power cord is damaged or if the electrical outlet is not grounded.</p> <p>This could result in electric shock or fire.</p>
	<p>Do not place anything on top of the machine (water, small metal or heavy objects, candles, lit cigarettes, etc.).</p> <p>This could result in electric shock or fire.</p>
	<ul style="list-style-type: none">If the machine gets overheated, it releases smoke, makes strange noises, or generates an odd odor, immediately turn off the power switch and unplug the machine.The user should be able to access the power outlet in case of emergencies that might require the user to pull the plug out. <p>This could result in electric shock or fire.</p>
	<p>Do not bend, or place heavy objects on the power cord.</p> <p>Stepping on or allowing the power cord to be crushed by a heavy object could result in electric shock or fire.</p>
	<p>Do not remove the plug by pulling on the cord; do not handle the plug with wet hands.</p> <p>This could result in electric shock or fire.</p>







Safety information

Caution

	<p>During an electrical storm or for a period of non-operation, remove the power plug from the electrical outlet.</p> <p>This could result in electric shock or fire.</p>
	<p>Be careful, the paper output area is hot.</p> <p>Burns could occur.</p>
	<p>If the machine has been dropped, or if the cabinet appears damaged, unplug the machine from all interface connections and request assistance from qualified service personnel.</p> <p>Otherwise, this could result in electric shock or fire.</p>
	<p>If the machine does not operate properly after these instructions have been followed, unplug the machine from all interface connections and request assistance from qualified service personnel.</p> <p>Otherwise, this could result in electric shock or fire.</p>
	<p>If the plug does not easily enter the electrical outlet, do not attempt to force it in.</p> <p>Call an electrician to change the electrical outlet, or this could result in electric shock.</p>
	<p>Do not allow pets to chew on the AC power, telephone or PC interface cords.</p> <p>This could result in electric shock or fire and/or injury to your pet.</p>

Operating method

Caution

	<p>Do not forcefully pull the paper out during printing.</p> <p>It can cause damage to the machine.</p>
	<p>Be careful not to put your hand between the machine and paper tray.</p> <p>You may get injured.</p>
	<p>Be careful when replacing paper or removing jammed paper.</p> <p>New paper has sharp edges and can cause painful cuts.</p>
	<p>When printing large quantities, the bottom part of the paper output area may get hot. Do not allow children to touch.</p> <p>Burns can occur.</p>
	<p>When removing jammed paper, do not use tweezers or sharp metal objects.</p> <p>It can damage the machine.</p>
	<p>Do not allow too many papers to stack up in the paper output tray.</p> <p>It can damage the machine.</p>

Safety information



Do not block or push objects into the ventilation opening.
This could result in elevated component temperatures which can cause damage or fire.



Use of controls or adjustments or performance of procedures other than those specified herein may result in hazardous radiation exposure.



This machine's power reception device is the power cord.
To switch off the power supply, remove the power cord from the electrical outlet.

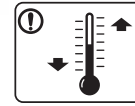

Place the machine in the environment where it meets the operating temperature and humidity specification.

Do not use the machine when it is below freezing temperature or has recently been moved from a location below freezing temperature. Doing so may damage the machine. Only operate the machine when the internal temperature of the machine is within the operating temperature and humidity specifications.

Otherwise, quality problems can occur and cause damage to the machine.

See "General specifications" on page 68.

Installation / Moving

Warning



Do not place the machine in an area with dust, humidity, or water leaks.

This could result in electric shock or fire.

Safety information

Caution



Before moving the machine, turn the power off and disconnect all cords. The information below are only suggestions based on the units weight.

If you have a medical condition that prevents you from lifting, do not lift the machine. Ask for help, and always use the appropriate amount of people to lift the device safety.

Then lift the machine:

- If the machine weighs under 20 kg (44.09 lbs), lift with 1 person.
- If the machine weighs 20 kg (44.09 lbs) - 40kg (88.18 lbs), lift with 2 people.
- If the machine weighs more than 40 kg (88.18 lbs), lift with 4 or more people.

The machine could fall, causing injury or machine damage.

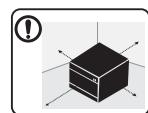

Choose a flat surface with enough space for ventilation to place the machine. Also consider the space required to open the cover and trays.

The place should be well-ventilated and be far from direct light, heat, and humidity.



When using the machine for a long period of time or printing a large number of pages in a non-ventilated space, it could pollute the air and be harmful to your health. Place the machine in a well-ventilated space or open a window to circulate the air periodically.



Do not place the machine on an unstable surface.
The machine could fall, causing injury or machine damage.



Use only No.26 AWG^a or larger, telephone line cord, if necessary.
Otherwise, it can cause damage to the machine.



Make sure you plug the power cord into a grounded electrical outlet.
Otherwise, this could result in electric shock or fire.



Use the power cord supplied with your machine for safe operation. If you are using a cord which is longer than 2 meters (6 feet) with a 110V machine, then the gauge should be 16 AWG or larger.
Otherwise, it can cause damage to the machine, and could result in electric shock or fire.



Do not put a cover over the machine or place it in an airtight location, such as a closet.
If the machine is not well-ventilated, this could result in fire.



Do not overload wall outlets and extension cords.
This can diminish performance, and could result in electric shock or fire.



The machine should be connected to the power level which is specified on the label.
If you are unsure and want to check the power level you are using, contact the electrical utility company.

a. AWG: American Wire Gauge

Safety information

Maintenance / Checking

Caution



Unplug this product from the wall outlet before cleaning the inside of the machine. Do not clean the machine with benzene, paint thinner or alcohol; do not spray water directly into the machine.

This could result in electric shock or fire.



When you are working inside the machine replacing consumables or cleaning the inside, do not operate the machine. You could get injured.



Keep cleaning consumables away from children. Children could get hurt.



Do not disassemble, repair or rebuild the machine by yourself. It can damage the machine. Call a certified technician when the machine needs repairing.



To clean and operate the machine, strictly follow the user's guide provided with the machine. Otherwise, you could damage the machine.



Keep the power cable and the contact surface of the plug clean from dust or water.

Otherwise, this could result in electric shock or fire.



- Do not remove any covers or guards that are fastened with screws.
- Fuser units should only be repaired by a certified service technician. Repair by non-certified technicians could result in fire or electric shock.
- The machine should only be repaired by a Samsung service technician.

Supply usage

Caution







Do not disassemble the toner cartridge. Toner dust can be dangerous if inhaled or ingested.



Do not burn any of the consumables such as toner cartridge or fuser unit. This could cause an explosion or uncontrollable fire.

Safety information

	<p>When storing consumables such as toner cartridges, keep them away from children.</p> <p>Toner dust can be dangerous if inhaled or ingested.</p>
	<p>Using recycled consumables, such as toner, can cause damage to the machine.</p> <p>In case of damage due to the use of recycled consumables, a service fee will be charged.</p>
	<p>For consumables that contain toner dust (toner cartridge, waste toner bottle, imaging unit, etc.) follow the instructions below.</p> <ul style="list-style-type: none">• When disposing of the consumables, follow the instructions for disposal. Refer to the reseller for disposal instructions.• Do not wash the consumables.• For a waste toner bottle, do not reuse it after emptying the bottle. <p>If you do not follow the instructions above, it may cause machine malfunction and environmental pollution. The warranty does not cover damages caused by a user's carelessness.</p>
	<p>When toner gets on your clothing, do not use hot water to wash it.</p> <p>Hot water sets toner into fabric. Use cold water.</p>
	<p>When changing the toner cartridge or removing jammed paper, be careful not to let toner dust touch your body or clothes.</p> <p>Toner dust can be dangerous if inhaled or ingested.</p>

Machine overview

Components

The actual component may differ from the illustration below. Some components may change depending on the configuration.

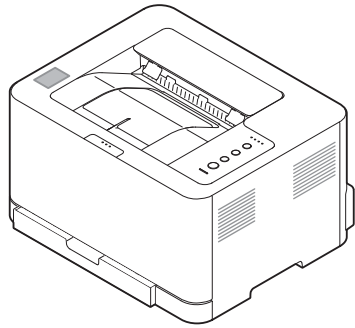

Machine

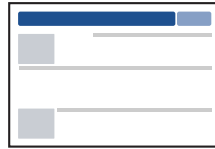

Quick installation guide



Power cord

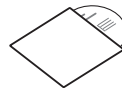

Software CD^a

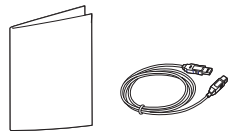

Misc. accessories^b

a. The software CD contains the print drivers, user's guide, and software applications.

b. Miscellaneous accessories included with your machine may vary by country of purchase and specific model.

Machine overview

Front view



- This illustration may differ from your machine depending on its model.
- Some features and optional goods may not be available depending on model or country (see "Features by model" on page 6).

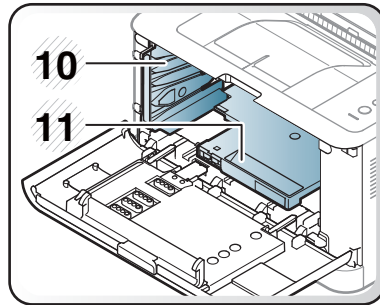
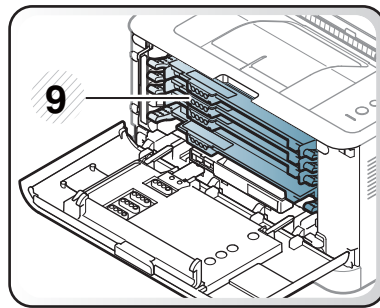
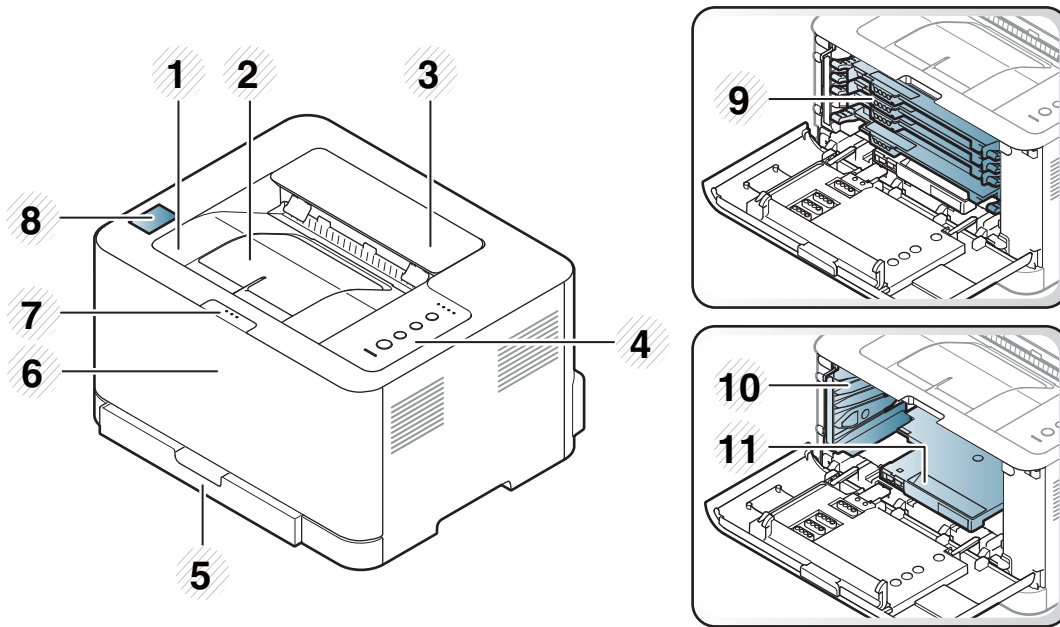

1	Output tray	7	Front cover release button
2	Output support	8	NFC tag ^a
3	Top cover	9	Toner cartridges
4	Control Panel	10	Waster toner container
5	Tray	11	Imaging unit
6	Front cover		

a. C43xW series only.

Machine overview

Rear view



- This illustration may differ from your machine depending on its model.
- Some features and optional goods may not be available depending on model or country (see "Features by model" on page 6).

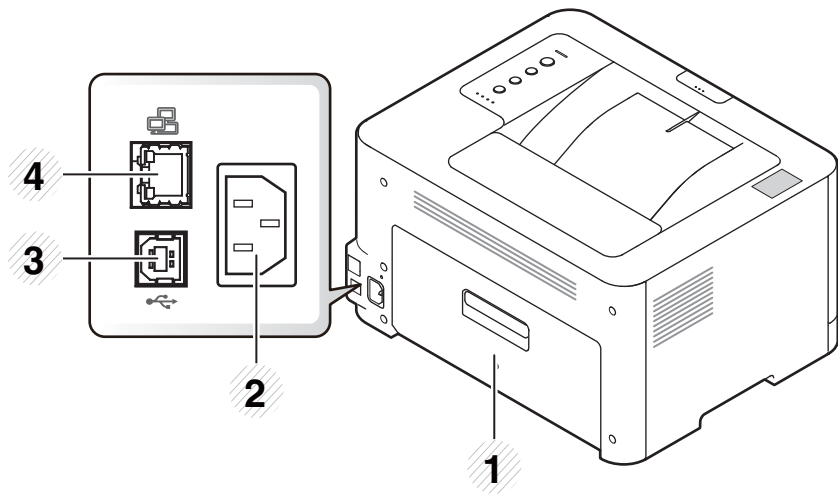

- | | |
|---|------------------|
| 1 | Rear cover |
| 2 | Power receptacle |
| 3 | USB port |
| 4 | Network port |

Control panel overview



This control panel may differ from your machine depending on its model. There are various types of control panels.

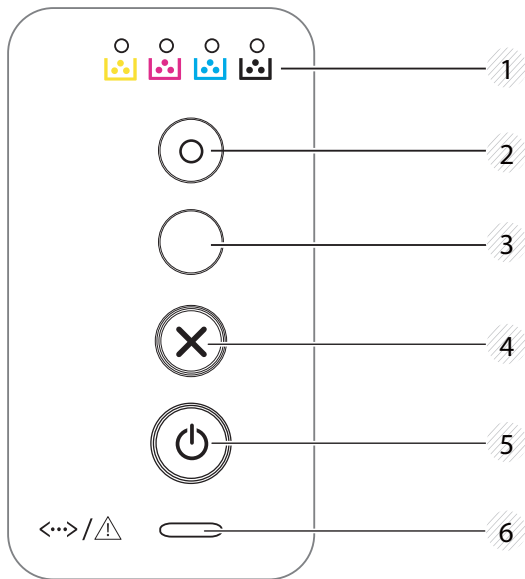

1	Toner LED	Shows the status of the toner (see "Status LED" on page 64).
2	Eco	Turn into eco mode to reduce toner consumption and paper usage when pc-printing only (see "Eco printing" on page 39).

3



(WPS)^a

Configures the wireless network connection easily without a computer (see "Wireless network setup" on page 109).

- **Manual print**

- Press this button each time you load a sheet of paper in the tray if you have selected **Manual Feeder** for **Source** in your printer driver.



(Print screen)^b



- **Prints the screen**

- Press this button and the blue LED will start blinking. If you want to print only the active screen, release the button when the blue LED stops blinking. If you want to print the whole screen, release the button while it's blinking.
- **Manual print**
 - Press this button each time you load a sheet of paper in the tray if you have selected **Manual Feeder** for **Source** in your printer driver.



- **Print Screen** can only be used in the Windows and Mac operating systems.
- You can only use this function with USB-connected machine.
- When printing the active window/whole monitor screen using the print screen button, the machine may use more toner depending on what is being printed.
- You can only use this function if the machine's Easy Printer Manager program is installed if you are a Mac OS user, you need to enable **Screen Print Settings** from the Easy Printer Manager to use the Print Screen feature.

Control panel overview

4	 (Cancel)	<p>You can stop an operation at any time. You also can do the following functions.</p> <ul style="list-style-type: none">• Configuration / Network Configuration Report^a<ul style="list-style-type: none">- Press and hold this button for about 2 seconds until the blue LED blinks slowly, and release.• Error Information / Usage Counter<ul style="list-style-type: none">- Press and hold this button for about 4 seconds until the blue LED blinks quickly, and release.• Supplies Information<ul style="list-style-type: none">- Press and hold this button for about 6 seconds until the blue LED on, and release.
5	 (Power/ Wake Up)	<p>You can turn the power off or wake the machine up from the sleep mode with this button.</p>
6	 (Status LED)	<p>Shows the status of your machine (see "Status LED" on page 64).</p>

a. C43xW series only.

b. C43x series only.

Turning on the machine



Keep in mind that you should use the power cord supplied with the machine. Otherwise, it can cause damage or fire to the machine.

- 1 Connect the machine to the electricity supply first.

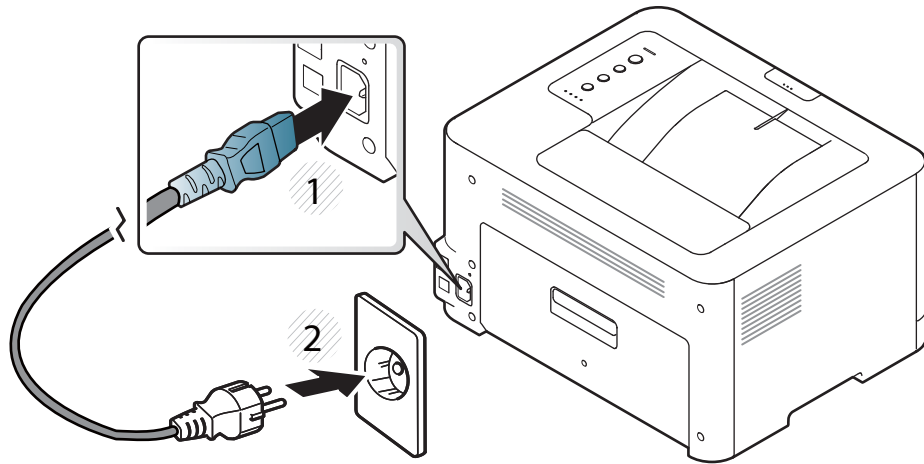

- 2 press  (**Power/Wake Up**) button on the control panel.



If you want to turn the power off, press and hold  (**Power/Wake Up**) button for about 3 seconds.

Installing the driver locally

A locally connected machine is a machine directly attached to your computer using a USB cable. If your machine is attached to a network, skip the following steps below and go on to installing a network connected machine's driver (see "Installing driver over the network" on page 102).



- If you are a Mac or Linux operating systems user, refer to the "Installation for Mac" on page 93 or "Installation for Linux" on page 95.
- The installation window in this User's Guide may differ depending on the machine and interface in use.
- Only use a USB cable no longer than 3 meters (118 inches).

Windows

- 1 Make sure that the machine is connected to your computer and powered on.
- 2 Insert the supplied software CD into your CD-ROM drive.
If the installation window does not appear, click **Start > All programs > Accessories > Run**.
X:**Setup.exe** replacing "X" with the letter, which represents your CD-ROM drive and click **OK**.
 - For Windows 8,

If the installation window does not appear, from **Charms**, select **Search > Apps** and search for **Run**. Type in X:\Setup.exe, replacing "X" with the letter that represents your CD-ROM drive and click **OK**.

If "**Tap to choose what happens with this disc.**" pop-up window appears, click the window and select **Run Setup.exe**.

- 3 Review and accept the installation agreements in the installation window. Then, click **Next**.
- 4 Select **USB** on the **Printer Connection Type** screen. Then, click **Next**.
- 5 Follow the instructions in the installation window.



You can select the software applications in the **Select Software to Install** window.

Installing the driver locally

From the Windows 8 Start Screen



- The V4 driver is automatically downloaded from the Windows Update if your computer is connected to the Internet. If not, you can manually download the V4 driver from Samsung website, www.samsung.com > find your product > Support or downloads.
- You can download Samsung Printer Experience app from the **Windows Store**. You need have a Microsoft account to use the Windows **Store**.
 - 1 From **Charms**, select **Search**.
 - 2 Click **Store**.
 - 3 Search and click **Samsung Printer Experience**.
 - 4 Click **Install**.
- If you install the driver using the supplied software CD, V4 driver is not installed. If you want to use the V4 driver in the **Desktop** screen, you can download from the Samsung website, www.samsung.com > find your product > Support or downloads.
- If you want to install Samsung's printer management tools, you need to install them using the supplied software CD.

- 1 Make sure that your computer is connected to the Internet and powered on.
- 2 Make sure that the machine is powered on.
- 3 Connect the computer and the machine with a USB cable.
The driver is automatically installed from the **Windows Update**.

Reinstalling the driver

If the printer driver does not work properly, follow the steps below to reinstall the driver.

Windows

- 1 Make sure that the machine is connected to your computer and powered on.
- 2 From the **Start** menu, select **Programs** or **All Programs** > **Samsung Printers** > **Uninstall Samsung Printer Software**.
 - For Windows 8,
 - 1 From Charms, select **Search** > **Apps**.
 - 2 Search and click **Control Panel**.
 - 3 Click **Programs and Features**.
 - 4 Right-click the driver you want to uninstall and select **Uninstall**.
- 3 Follow the instructions in the installation window.
- 4 Insert the software CD into your CD-ROM drive and install the driver again (see "Installing the driver locally" on page 23).

From the Windows 8 Start Screen

- 1 Make sure that the machine is connected to your computer and powered on.
- 2 Click on the **Uninstall Samsung Printer Software** in the **Start** screen.
- 3 Follow the instructions in the window.



- If you cannot find a Samsung Printer Software tile, uninstall from the desktop screen mode.
- If you want to uninstall Samsung's printer management tools, from the **Start** screen, right-click the app > **Uninstall** > right-click the program you want to delete > **Uninstall** and follow the instruction in the window.



2. Learning the Basic Usage

After installation is complete, you may want to set the machine's default settings. Refer to the next section if you would like to set or change values. This chapter provides information about the overall menu structure and the basic setup options.

- **Media and tray** 27
- **Basic printing** 36

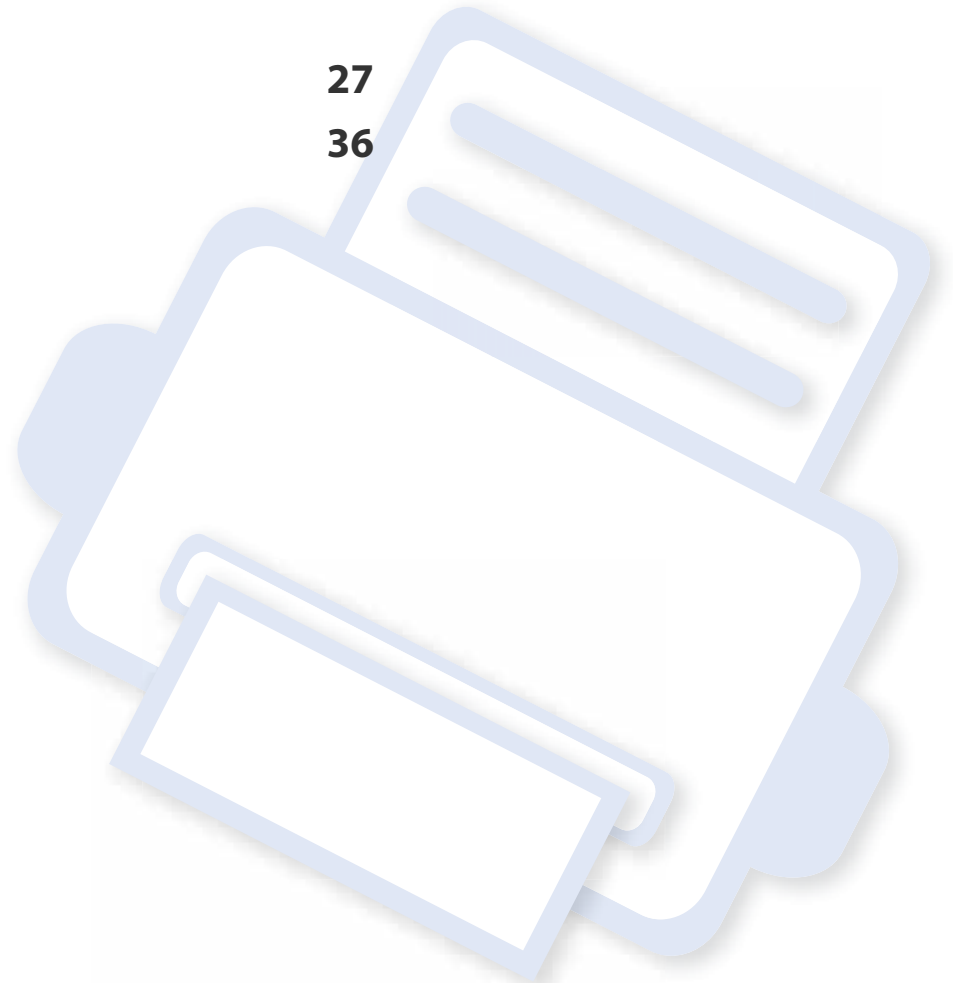

Media and tray

This chapter provides information on how to load print media into your machine.

Selecting print media

You can print on a variety of print media, such as plain paper, envelopes, labels, and transparencies. Always use print media that meet the guidelines for use with your machine.

Guidelines for select the print media

Print media that does not meet the guidelines outlined in this user's guide may cause the following problems:

- Poor print quality
- Increased paper jams
- Premature wear on the machine.

Properties, such as weight, composition, grain, and moisture content, are important factors that affect the machine's performance and the output quality.

When you choose print materials, consider the following:

- The type, size, and weight of the print media for your machine are described in print media specifications (see "Print media specifications" on page 70).
- Desired outcome: The print media you choose should be appropriate for your project.

- **Brightness:** Some print media are whiter than others and produce sharper, more vibrant images.
- **Surface smoothness:** The smoothness of the print media affects how crisp the printing looks on the paper.



- Some print media may meet all of the guidelines in this user's guide and still not produce satisfactory results. This may be the result of the sheets characteristics, improper handling, unacceptable temperature and humidity levels, or other variables over which cannot be controlled.
- Before purchasing large quantities of print media, ensure that it meets the requirements specified in this user's guide.



- Using print media that does not meet these specifications may cause problems or require repairs. Such repairs are not covered by Samsung's warranty or service agreements.
- The amount of paper put into the tray may differ according to media type used (see "Print media specifications" on page 70).
- Make sure not to use the inkjet photo paper with this machine. It could cause damage to the machine.
- Using flammable print media can cause a fire.
- Use designated print media (see "Print media specifications" on page 70).



The use of flammable media or foreign materials left in the printer may lead to overheating of the unit and, in rare cases may cause a fire.

Media and tray

The amount of paper put into the tray may differ according to media type used (see "Print media specifications" on page 70).

Tray overview

To change the size, you need to adjust the paper guide.

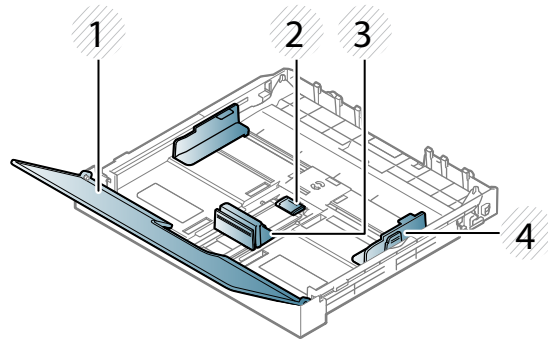

- 1 Paper cover
- 2 Guide lock
- 3 Paper length guide
- 4 Paper width guide



If you do not adjust the guide, it may cause paper registration, image skew, or jamming of the paper.

Media and tray

Loading paper in the tray

- 1 Pull out the paper tray (see "Tray overview" on page 28).

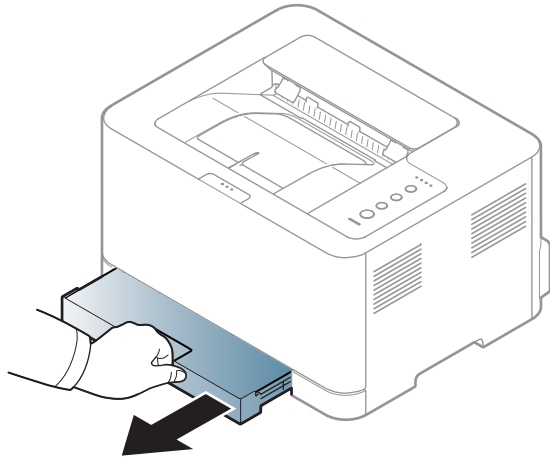

- 2 Open the paper cover.

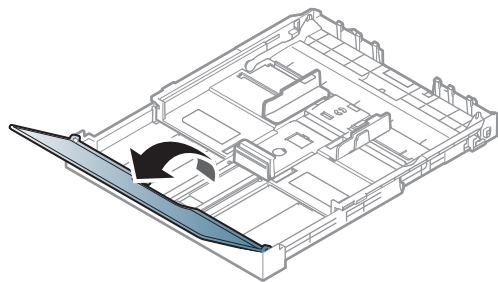

- 3 Squeeze and the paper width guide and paper length lever to locate them in the correct paper size slot marked at the bottom of the tray to adjust to the size.

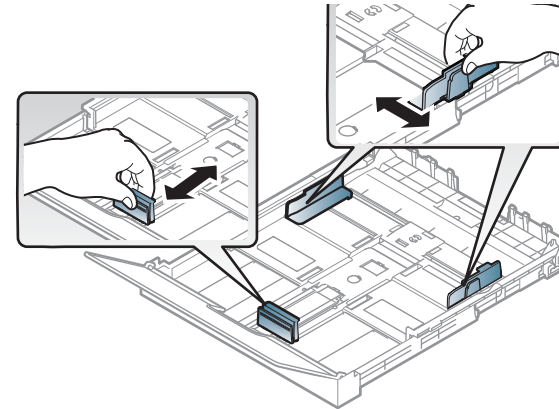

- 4 Flex or fan the edge of the paper stack to separate the pages before loading papers.

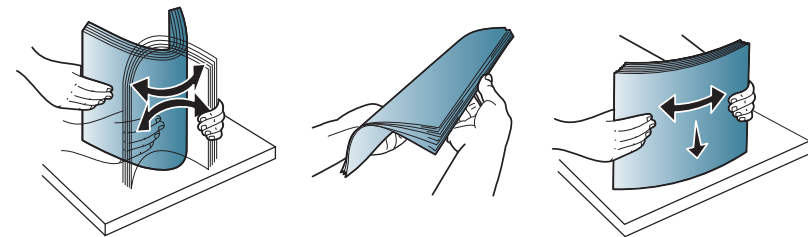

Media and tray

- 5 Place the paper with the side you want to print facing up.

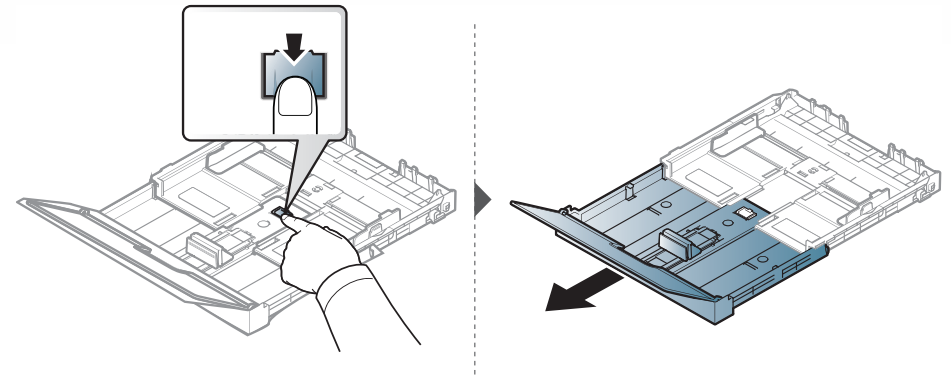
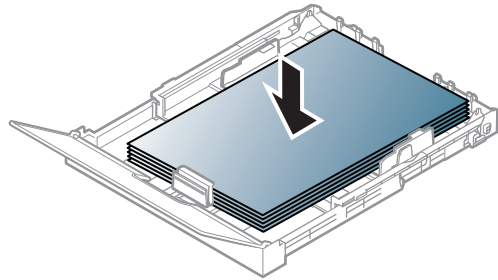

For paper smaller than Letter-sized, press and unlatch the guide lock in the tray, push the tray in manually. Then adjust the paper length guide and paper width guide.

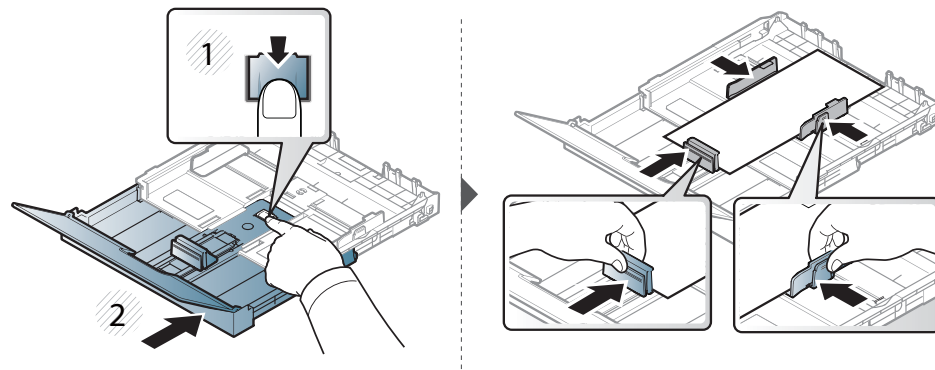

For paper longer than A4-sized (like 'Legal'), press and unlatch the guide lock in the tray, pull the tray out manually. Then adjust the paper length guide and paper width guide.



- Do not push the paper width guide too far causing the media to buckle.
- If you do not adjust the paper width guide, it may cause paper jams.

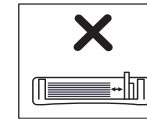
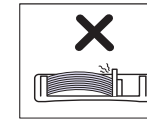
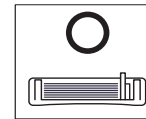

- Do not use a paper with a leading-edge curl, it may cause a paper jam or the paper can be wrinkled.

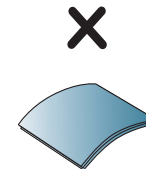
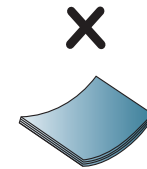
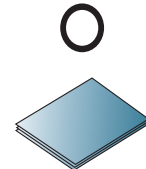

Media and tray

- 6 Squeeze the paper width guide and slide it to the edge of the paper stack without causing it to buckle.

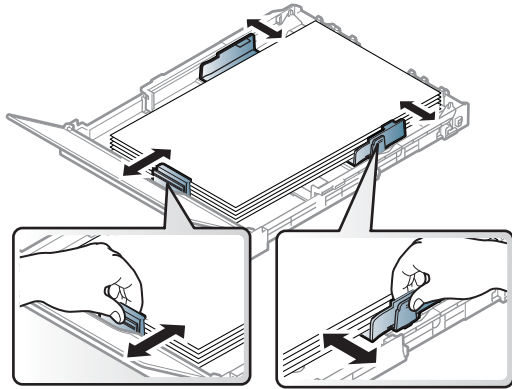

- 7 Close the paper cover.

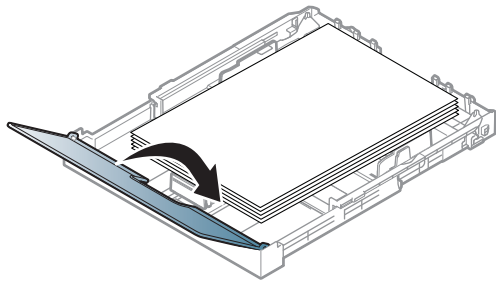

- 8 Insert the paper tray.

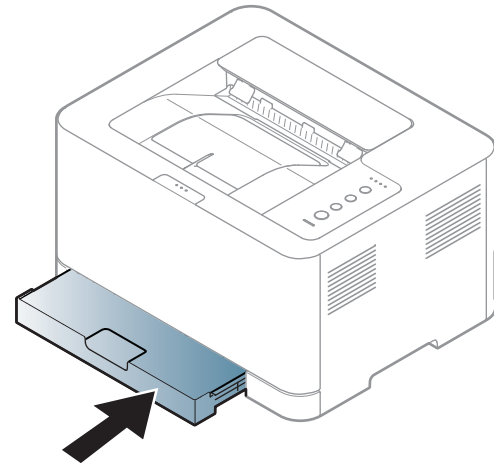

- 9 When you print a document, set the paper type and size for the tray (see "Setting the paper size and type" on page 35).

Media and tray

The tray is preset to Letter or A4 size, depending on your country. To change the size to A4 or Letter, you must adjust the lever and paper width guide properly.

- 1 Pull the tray out of the machine. Open the paper cover and remove paper from the tray if necessary.
- 2 If you want to change the size to Letter, hold the lever at the back of the tray, and rotate the lever clockwise. You can see the lever when you move the paper length guide to the legal-sized paper(LGL).

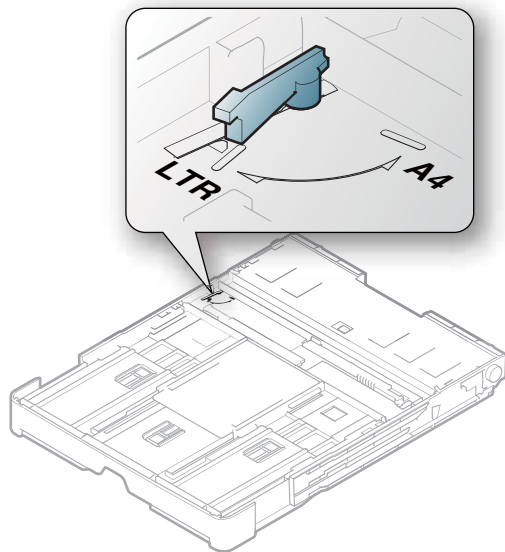

- 3 Squeeze the paper width guide and slide it to the edge of the lever.

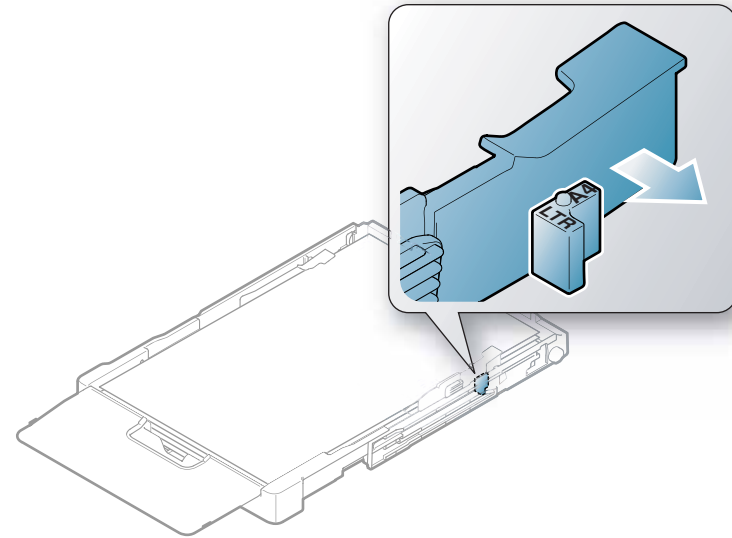

If you want to change the size to A4, first move the paper width guide to left and rotate the lever counterclockwise. If you force the lever, it could damage the tray.

Media and tray

Printing on special media

The paper setting in the machine and driver should match to print without a paper mismatch error.

- You change the paper setting set in the machine from Samsung Easy Printer Manager program or SyncThru™ Web Service.
 - If your machine is connected to the local, you can set the machine's setting from **Samsung Easy Printer Manager > Advanced Setting > Device Settings** (see "Using Samsung Easy Printer Manager" on page 164).
 - If your machine is connected to the network, you can set the machine's setting from **SyncThru™ Web Service > Settings tab > Machine Settings** (see "Using SyncThru™ Web Service" on page 161).



When using special media, we recommend you feed one sheet at a time (see "Print media specifications" on page 70).

To see paper weights for each sheet, refer to "Print media specifications" on page 70.

Types	Tray ^a
Plain	•
Thick	•
Thin	•

Types	Tray ^a
Bond	•
Color paper	•
CardStock	•
Labels	•
Preprinted	•
Cotton	•
Recycled	•
Archive	•
Glossy Photo	•
Matte Photo	•

a. The paper types available manual feeding in tray.

(•: Supported)

Media and tray

Labels

To avoid damaging the machine, use only labels designed for use in laser printers.

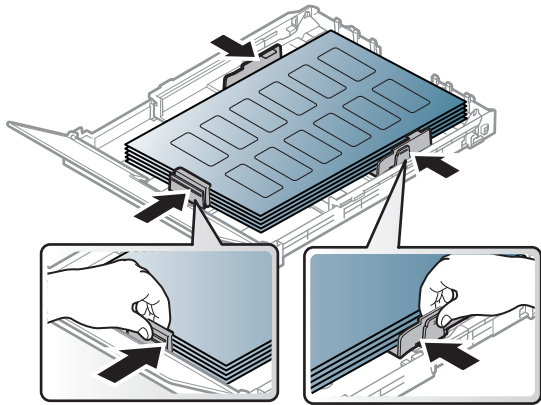

- When selecting labels, consider the following factors:
 - **Adhesives:** Should be stable at your machine's fusing temperature. Check your machine's specifications to view the fusing temperature (about 170°C (338°F)).
 - **Arrangement:** Only use labels with no exposed backing between them. Labels can peel off sheets that have spaces between the labels, causing serious jams.
 - **Curl:** Must lie flat with no more than 5 mm of curl in any direction.
 - **Condition:** Do not use labels with wrinkles, bubbles, or other indications of separation.

- Make sure that there is no exposed adhesive material between labels. Exposed areas can cause labels to peel off during printing, which can cause paper jams. Exposed adhesive can also cause damage to machine components.
- Do not run a sheet of labels through the machine more than once. The adhesive backing is designed for only a single pass through the machine.
- Do not use labels that are separating from the backing sheet or are wrinkled, bubbled, or otherwise damaged.

Card stock/ Custom-sized paper

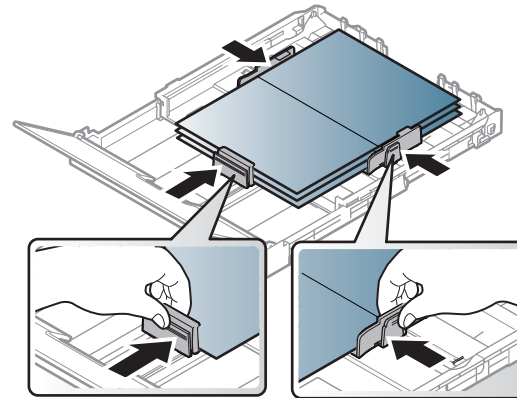

- In the software application, set margins at least 6.4 mm (0.25 inches) away from the edges of the material.

Media and tray

Preprinted paper

When loading preprinted paper, the printed side should be facing up with an uncurled edge at the front. If you experience problems with paper feeding, turn the paper around. Note that print quality is not guaranteed.

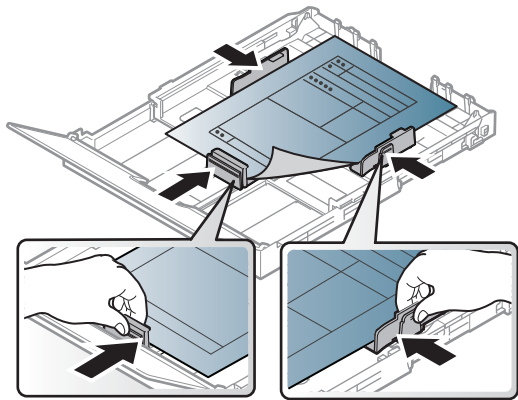

- Must be printed with heat-resistant ink that will not melt, vaporize, or release hazardous emissions when subjected to the machine's fusing temperature for 0.1 second (about 170°C (338°F)).
- Preprinted paper ink must be non-flammable and should not adversely affect machine rollers.
- Before you load preprinted paper, verify that the ink on the paper is dry. During the fusing process, wet ink can come off preprinted paper, reducing print quality.

Setting the paper size and type

After loading paper in the paper tray, set the paper size and type using the display screen. For computer printing, select the paper size and type in the application program you use on your computer (see "Opening Printing Preferences" on page 37).



The paper setting in the machine and driver should match to print without a paper mismatch error.

- You change the paper setting set in the machine from Samsung Easy Printer Manager program or SyncThru™ Web Service.
 - If your machine is connected to the local, you can set the machine's setting from **Samsung Easy Printer Manager > Advanced Setting > Device Settings** (see "Using Samsung Easy Printer Manager" on page 164).
 - If your machine is connected to the network, you can set the machine's setting from **SyncThru™ Web Service > Settings tab > Machine Settings** (see "Using SyncThru™ Web Service" on page 161).

Basic printing



For special printing features, refer to the Advanced Guide (see "Using advanced print features" on page 142).

Printing



If you are a Mac or Linux user, refer to the "Mac printing" on page 149 or "Linux printing" on page 151.

The following **Printing Preferences** window is for Notepad in Windows 7.

- 1 Open the document you want to print.
- 2 Select **Print** from the **File** menu.

- 3 Select your machine from the **Select Printer** list.

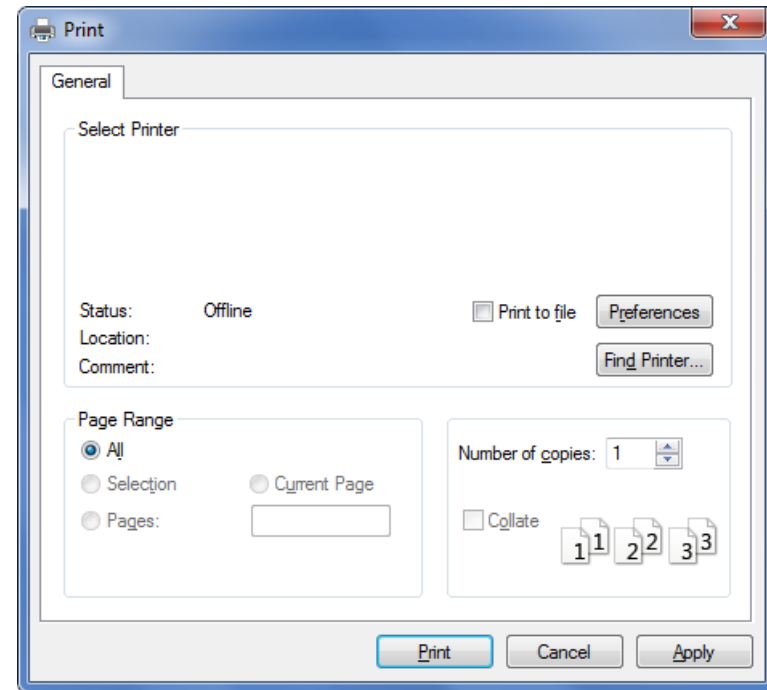

- 4 The basic print settings including the number of copies and print range are selected within the **Print** window.





To take advantage of the advanced printing features, click **Properties** or **Preferences** from the **Print** window (see "Opening Printing Preferences" on page 37).

- 5 To start the print job, click **OK** or **Print** in the **Print** window.

Basic printing





Canceling a print job

If the print job is waiting in the print queue or print spooler, cancel the job as follows:

- You can access this window by simply double-clicking the machine icon () in the Windows task bar.
- You can also cancel the current job by pressing  (**Cancel**) on the control panel.

Opening Printing Preferences



- The **Printing Preferences** window that appears in this user's guide may differ depending on the machine in use. However, the composition of the **Printing Preferences** window is similar.
- When you select an option in **Printing Preferences**, you may see a warning mark  or . An  mark means you can select that certain option but it is not recommended, and an  mark means you cannot select that option due to the machine's setting or environment.

- 1 Open the document you want to print.
- 2 Select **Print** from the file menu.
- 3 Select your machine from the **Select Printer**.
- 4 Click **Properties** or **Preferences**.

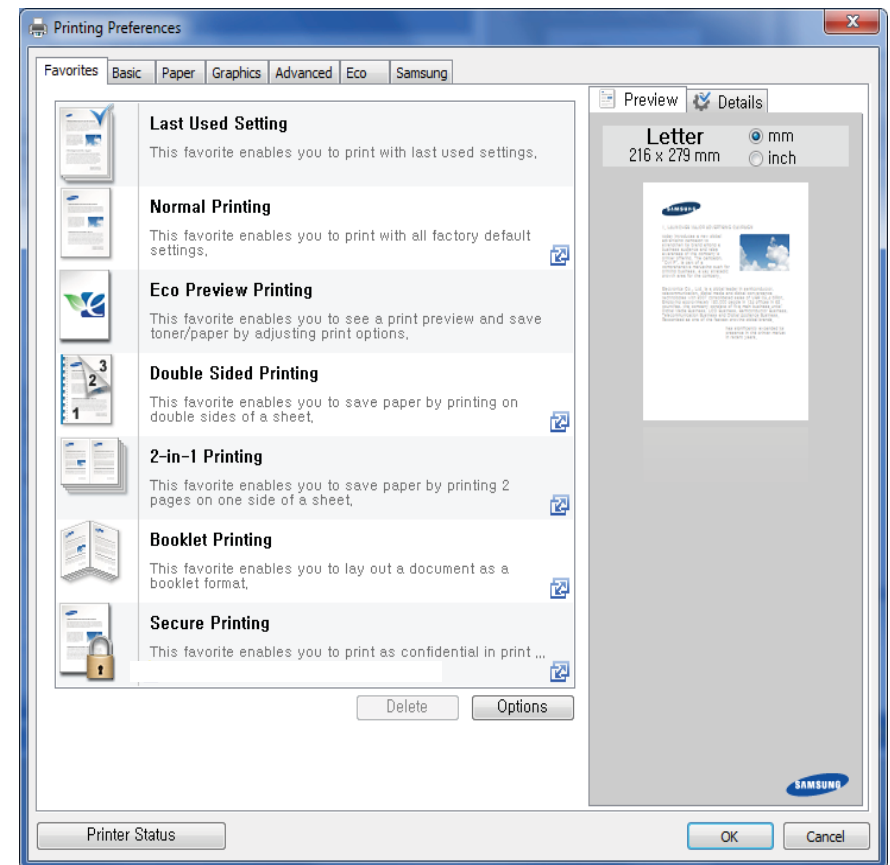

Basic printing



- You can apply **Eco** features to save paper and toner before printing (see "Easy Eco Driver" on page 157).
- You can check the machine's current status using the **Printer Status** button (see "Using Samsung Printer Status" on page 166).
- The printer driver includes a user interface that is optimized for touchscreens. To use this UI, click **Samsung Printer Center > Device Options** and then select **Stylish User Interface** (see "Using Samsung Printer Center" on page 158).

Using a favorite setting

The **Favorites** option, which is visible on each preferences tab except for the **Samsung** tab, allows you to save the current preferences for future use.

To save a **Favorites** item, follow these steps:

- 1 Change the settings as needed on each tab.
- 2 Enter a name for the item in the **Favorites** input box.

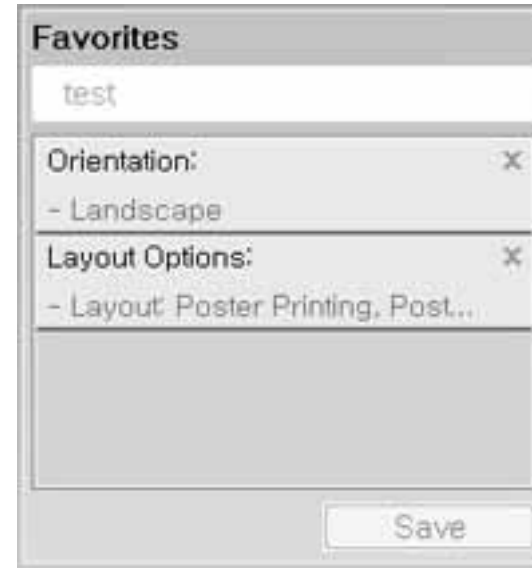

- 3 Click **Save**.
- 4 Enter name and description, and then select the desired icon.
- 5 Click **OK**. When you save **Favorites**, all current driver settings are saved.



To use a saved setting, select it in the **Favorites** tab. The machine is now set to print according to the settings you have selected.

To delete saved settings, select it in the **Favorites** tab and click **Delete**.

Basic printing

Using help

Click the option you want to know on the **Printing Preferences** window and press **F1** on your keyboard.

Eco printing

The **Eco** function cuts toner consumption and paper usage. The **Eco** function allows you to save print resources and lead you to eco-friendly printing.

If you press the **Eco** button from the control panel, eco mode is enabled. The default setting of Eco mode is **Multiple Pages per Side (2)** and **Toner Save**. Some features may not be available depending on the model.



- You change the machine's setting set in the machine from Samsung Easy Printer Manager or SyncThru™ Web Service.
 - If your machine is connected to the local, you can set the machine's setting from **Samsung Easy Printer Manager > Advanced Setting > Device Settings** (see "Using Samsung Easy Printer Manager" on page 164).
 - If your machine is connected to the network, you can set the machine's setting from **SyncThru™ Web Service > Settings tab > Machine Settings** (see "Using SyncThru™ Web Service" on page 161).



Depending on the printer driver you use, Skip blank pages may not work properly. If Skip blank pages feature does not work properly, set the feature from the Easy Eco Driver (see "Easy Eco Driver" on page 157).

Setting Eco mode on the control panel

If you press the **Eco** button from the control panel, eco mode is enabled. The default setting of Eco mode is **Multiple Pages per Side (2)** and **Toner Save**.



If you set the eco mode on with a password from the SyncThru™ Web Service (**Settings** tab > **Machine Settings** > **System** > **Eco Settings**) or Samsung Easy Printer Manager (**Device Settings** > **Eco**), the **On force** message appears. You have to enter the password to change the eco mode status.

Setting eco mode on the driver

Open the Eco tab to set Eco mode. When you see the eco image () , that means the eco mode is currently enabled.

Another way for Eco printing is to use the Easy Eco Driver application. See "Easy Eco Driver" on page 157.

Basic printing

Eco options

- **Printer Default:** Follows the settings from the machine's control panel.
- **None:** Disables Eco mode.
- **Eco Printing:** Enables eco mode. Activate the various Eco items you want to use.
- **Password:** If the administrator fixed to enable the Eco mode, you have to enter the password to change the status.

Result simulator

Result Simulator shows the estimated results of reduced emission of carbon dioxide, used electricity, and the amount of saved paper in accordance with the settings you selected.

- The results are calculated on the basis that the total number of printed paper is one hundred without a blank page when the Eco mode is disabled.
- Refers to the calculation coefficient about CO₂, energy, and paper from **IEA**, the index of Ministry of Internal Affairs and Communication of Japan and www.remanufacturing.org.uk. Each model has a different index.
- The power consumption in printing mode refers to the average printing power consumption of this machine.
- The actual amount displayed is only an estimate as the actual amount may differ depending on the operating system used, computing performance, application software, connection method, media type [thickness], media size, job complexity, etc.



3. Maintenance

This chapter provides information about purchasing supplies, accessories and maintenance parts available for your machine.

- **Ordering supplies and accessories** 42
- **Available supplies** 43
- **Available maintenance parts** 44
- **Storing the toner cartridge** 45
- **Redistributing toner** 47
- **Replacing the toner cartridge** 49
- **Replacing the waste toner container** 51
- **Replacing the imaging unit** 53
- **Cleaning the machine** 55
- **Tips for moving & storing your machine** 57

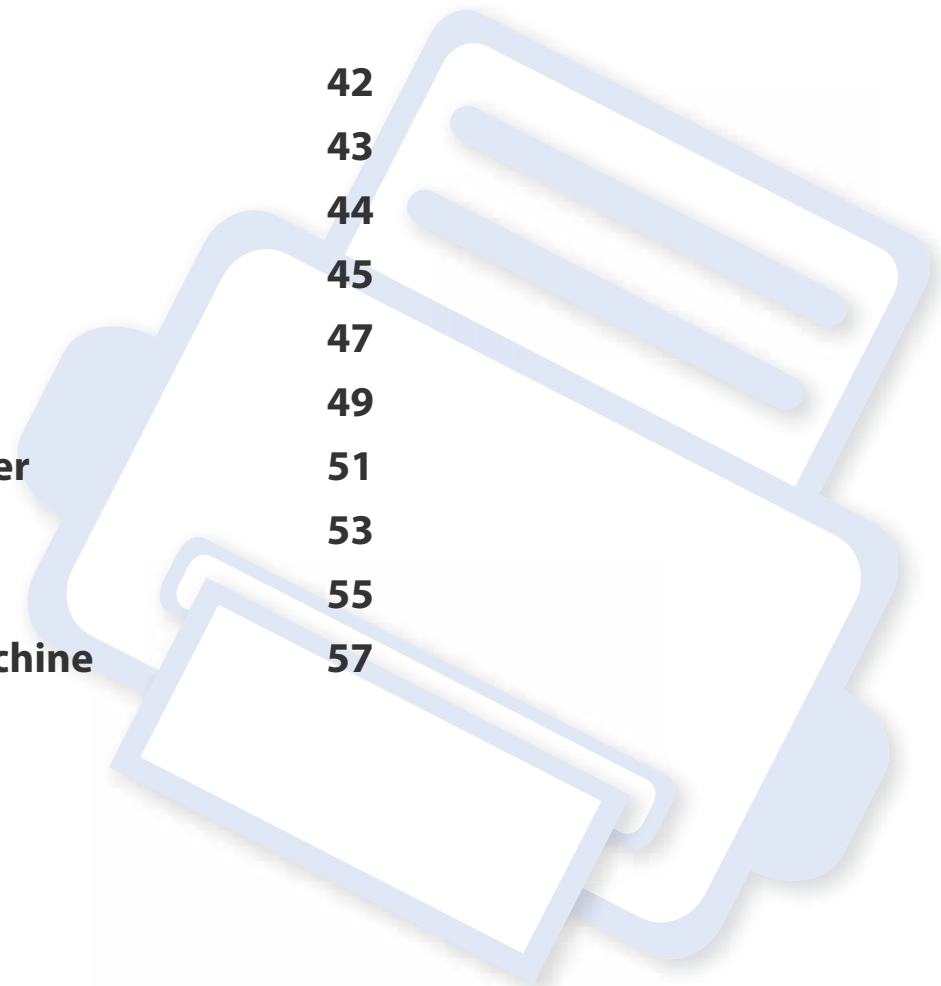

Ordering supplies and accessories



Available accessories may differ from country to country. Contact your sales representatives to obtain the list of available supplies, and maintenance parts.

To order Samsung-authorized supplies, accessories, and maintenance parts, contact your local Samsung dealer or the retailer where you purchased your machine. You can also visit www.samsung.com/supplies, and then select your country/region to obtain the contact information for service.

Available supplies

When supplies reach the end of their life spans, you can order the following types of supplies for your machine:

Type	Average yield ^a	Part name
Toner cartridge	<ul style="list-style-type: none">• Average continuous black cartridge yield: Approx. 1,500 standard pages (Black)• Average continuous color cartridge yield: Approx. 1,000 standard pages (Yellow/Magenta/Cyan)	<ul style="list-style-type: none">• K404 (CLT-K404S): Black• C404 (CLT-C404S): Cyan• M404 (CLT-M404S): Magenta• Y404 (CLT-Y404S): Yellow
Imaging unit	Approx. 16,000 images ^b	CLT-R406
Waste toner container	Approx. 7,000 images ^b	CLT-W406

a. Declared yield value in accordance with ISO/IEC 19798. The number of pages may be affected by operating environment, printing interval, graphics, media type and media size.

b. Image counts based on one color on each page. If you print documents in full color (Cyan, Magenta, Yellow, Black), the life of this item will be reduced by 25%.



Depending on the options, percentage of image area, and job mode used, the toner cartridge's lifespan may differ.



When purchasing new toner cartridges or other supplies, these must be purchased in the same country as the machine you are using. Otherwise, new toner cartridges or other supplies will be incompatible with your machine due to different configurations of toner cartridges and other supplies according to the specific country conditions.



- The toner cartridge included in the printer/all-in-one product you purchased is not available for sale and is not guaranteed to be compatible with any other printer.
- Samsung does not recommend using non-genuine Samsung toner cartridge such as refilled or remanufactured toner. Samsung cannot guarantee non-genuine Samsung toner cartridge's quality. Service or repair required as a result of using non-genuine Samsung toner cartridges will not be covered under the machine's warranty.

Available maintenance parts

You need to replace the maintenance parts at specific intervals to keep the machine in the best condition and avoid print quality and paper feeding problems resulting from the worn-out parts. Maintenance parts are mostly rollers, belts and pads. However, the replacement period and parts may differ depending on the model. Replacing maintenance parts can be performed only by an authorized service provider, dealer, or the retailer where you bought the machine. To purchase maintenance parts, contact the retailer where you bought the machine. The replacement period for the maintenance parts is informed by the "Samsung Printer Status" program. Or on the UI (User Interface) if your machine supports a display screen. The replacement period varies based on the operating system used, computing performance, application software, connecting method, paper type, paper size, and job complexity.

Storing the toner cartridge

Toner cartridges contain components that are sensitive to light, temperature and humidity. Samsung suggests users follow these recommendations to ensure optimal performance, highest quality, and longest life from your new Samsung toner cartridge.

Store this cartridge in the same environment in which the printer will be used. This should be in controlled temperature and humidity conditions. The toner cartridge should remain in its original and unopened package until installation – if original packaging is not available, cover the top opening of the cartridge with paper and store in a dark cabinet.

Opening the cartridge package prior to use dramatically shortens its useful shelf and operating life. Do not store on the floor. If the toner cartridge is removed from the printer, follow the instructions below to store the toner cartridge properly.

- Store the cartridge inside the protective bag from the original package.
- Store lying flat (not standing on end) with the same side facing up as if it were installed in the machine.
- Do not store consumables in any of the following conditions:
 - Temperature greater than 40°C (104°F).
 - Humidity range less than 20% and greater than 80%.
 - An environment with extreme changes in humidity or temperature.
 - Direct sunlight or room light.
 - Dusty places.
 - A car for a long period of time.
 - An environment where corrosive gases are present.
 - An environment with salty air.

Storing the toner cartridge

Handling instructions

- Do not touch the surface of the photoconductive drum in the cartridge.
- Do not expose the cartridge to unnecessary vibrations or shock.
- Never manually rotate the drum, especially in the reverse direction; this can cause internal damage and toner spillage.

Toner cartridge usage

Samsung Electronics does not recommend or approve the use of non-Samsung brand toner cartridges in your printer including generic, store brand, refilled, or remanufactured toner cartridges.



Samsung's printer warranty does not cover damage to the machine caused by the use of a refilled, remanufactured, or non-Samsung brand toner cartridges.

Estimated cartridge life

Estimated cartridge life the life of the toner cartridge (or imaging unit) yield depends on the amount of toner that print jobs require. The actual print yield may vary depending on the print density of the pages you print on, operating environment, percentage of image area, printing interval, media type and/or media size. For example, if you print a lot of graphics, the consumption of the toner is higher and you may need to change the cartridge more often.

Redistributing toner

When the toner cartridge is near the end of its life:

- White streaks or light printing occurs and/or density varies from side to side.
- The **Toner** LED blinks orange. The toner-related message saying that the toner is low may appear on the display.
- The computer's Samsung Printing Status program window appears on the computer telling you which color cartridge is low on toner (see "Using Samsung Printer Status" on page 166).

If this happens, you can temporarily improve print quality by redistributing the remaining toner in the cartridge. In some cases, white streaks or light printing will still occur even after you have redistributed the toner.



Illustrations on this user's guide may differ from your machine depending on its options or models. Check your machine type (see "Front view" on page 18).



- Before opening the top cover, close the output support first.
- Do not use sharp objects such as a knife or scissors to open the toner cartridge package. They might scratch the drum of the cartridge.
- If toner gets on your clothing, wipe it off with a dry cloth and wash clothing in cold water. Hot water sets toner into fabric.
- Printing even after the toner empty status can cause serious damage to your machine.

Redistributing toner

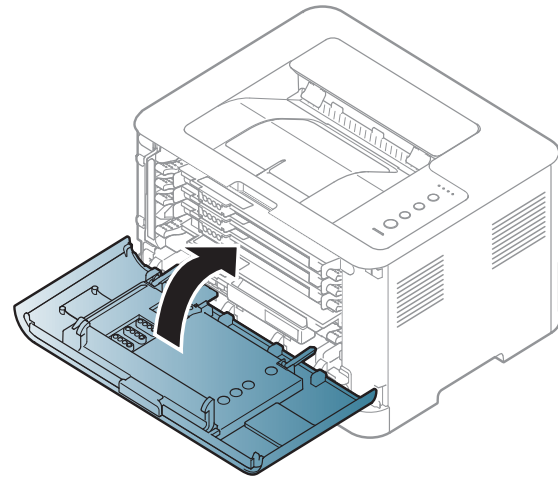
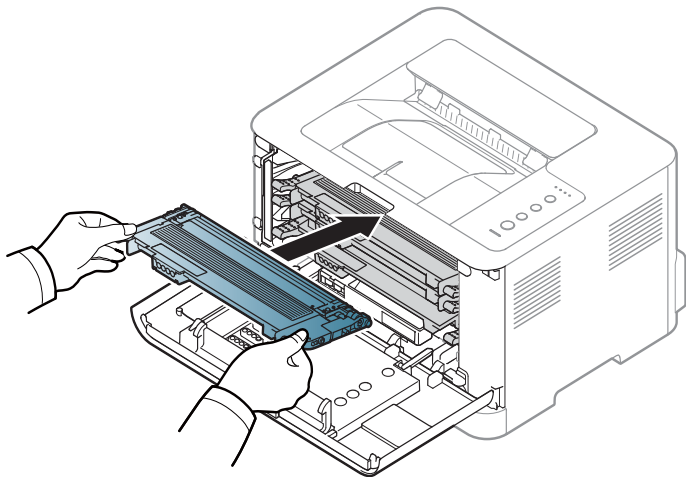
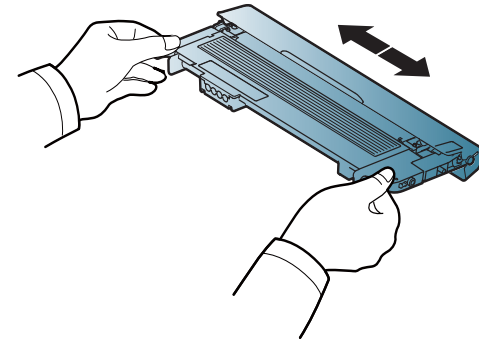
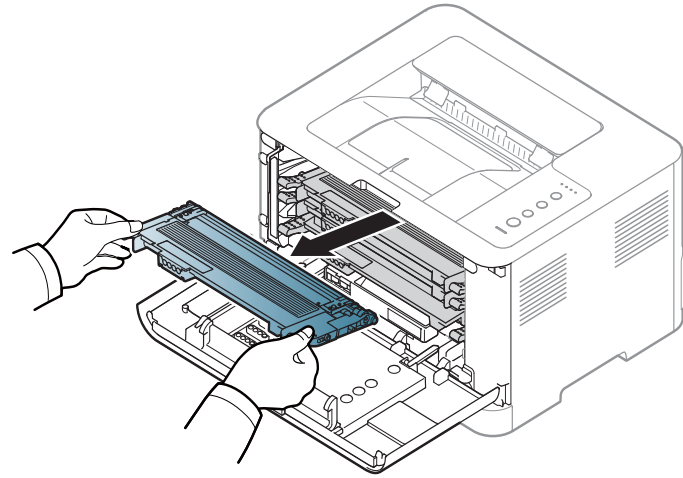
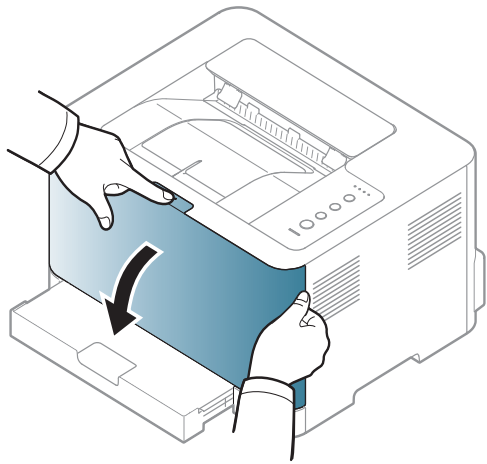

Replacing the toner cartridge



- Before opening the top cover, close the output support first.
- Do not use sharp objects such as a knife or scissors to open the toner cartridge package. They might scratch the drum of the cartridge.
- If toner gets on your clothing, wipe it off with a dry cloth and wash clothing in cold water. Hot water sets toner into fabric.
- Shake the toner cartridge thoroughly, it will increase the initial print quality.
- Do not touch the green underside of the toner cartridge. Use the handle on the cartridge to avoid touching this area.
- Printing even after the toner empty status can cause serious damage to your machine.

Replacing the toner cartridge

When a toner cartridge has reached the end of life, the Printing Status window appears on the computer, indicating the toner cartridge needs to be placed.

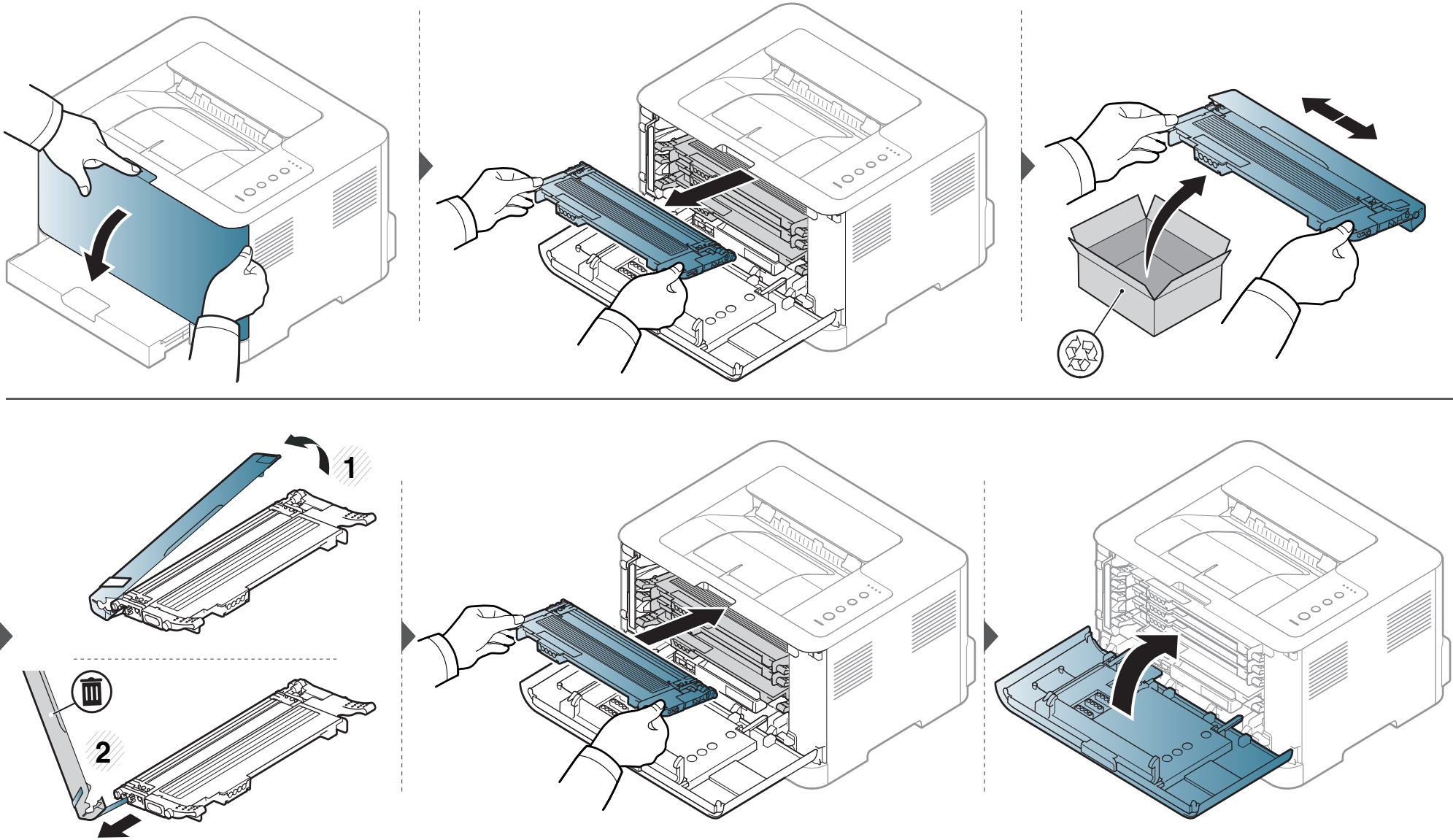

Replacing the waste toner container

When the life span of the waste toner container has expired, the Smart Panel program window appears on the computer, indicating the waste toner container needs to be placed. Otherwise your printer stops printing.



- Toner particles can be released inside the machine but it does not mean the machine is damaged. Contact a service representative when print quality problems occur.
- When you pull out the waste toner container out of the machine, move the container carefully not to drop it from your hands.
- Make sure that you lay the waste toner container on a flat surface so that the toner does not spill.



Do not tilt or turn over the container.

Replacing the waste toner container

The order information is provided for optional accessories (see "Available supplies" on page 43).

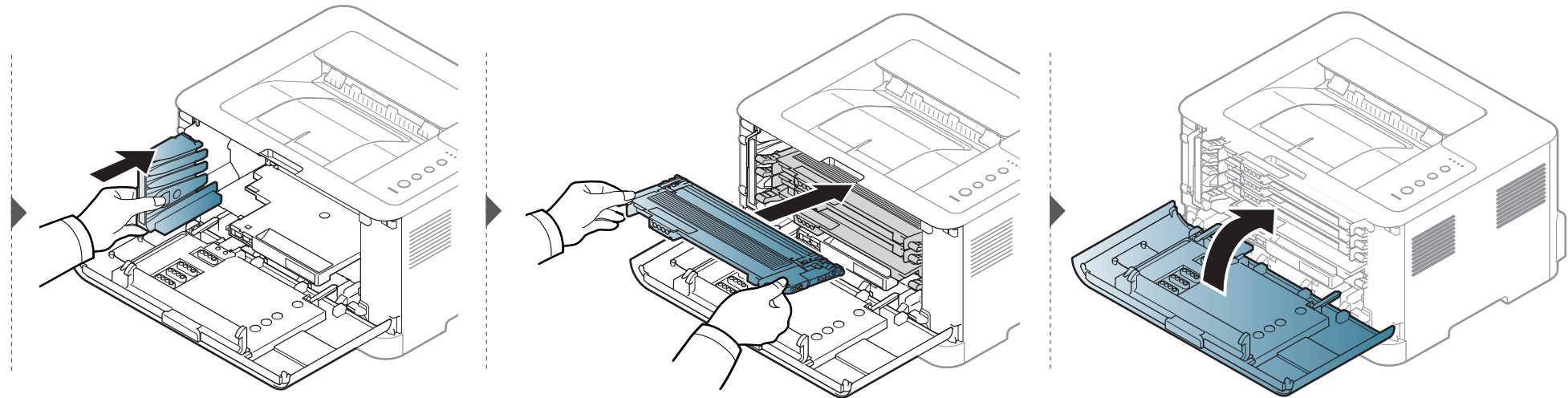
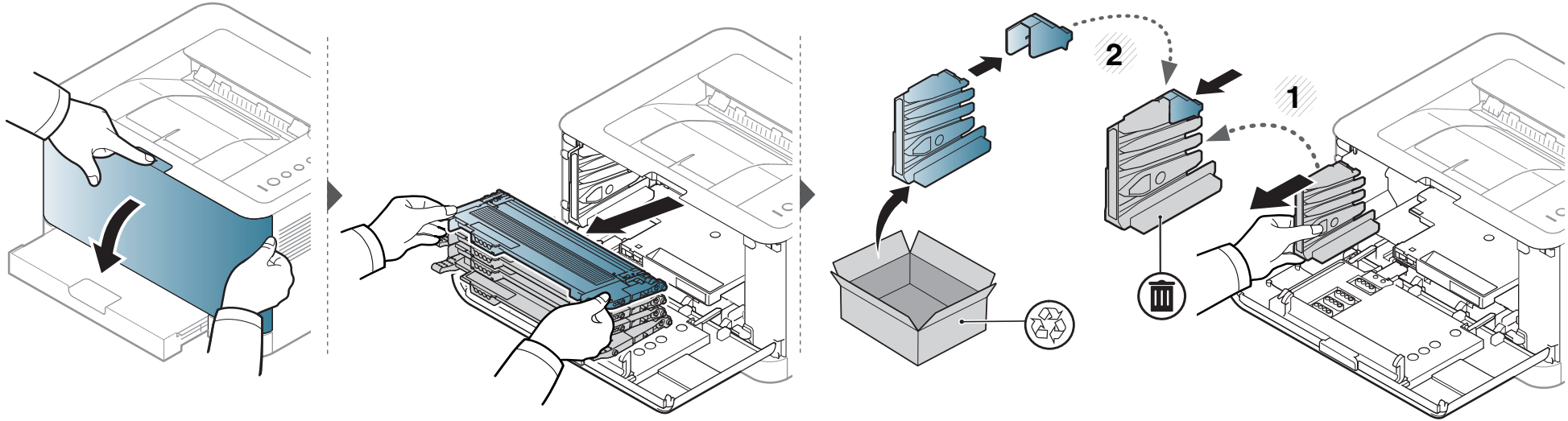

Replacing the imaging unit

When the life span of the imaging unit has expired, the Smart Panel program window appears on the computer, indicating the imaging unit needs to be placed. Otherwise, your machine stops printing.



- Don't use sharp objects such as a knife or scissors to open the imaging unit package. You could damage the surface of the imaging unit.
- Be careful not to scratch the surface of the imaging unit.
- To prevent damage, do not expose the imaging unit to light for more than a few minutes. Cover it with a piece of paper to protect it if necessary.
- Before closing the front cover, make sure all toner cartridges are installed properly.

Replacing the imaging unit

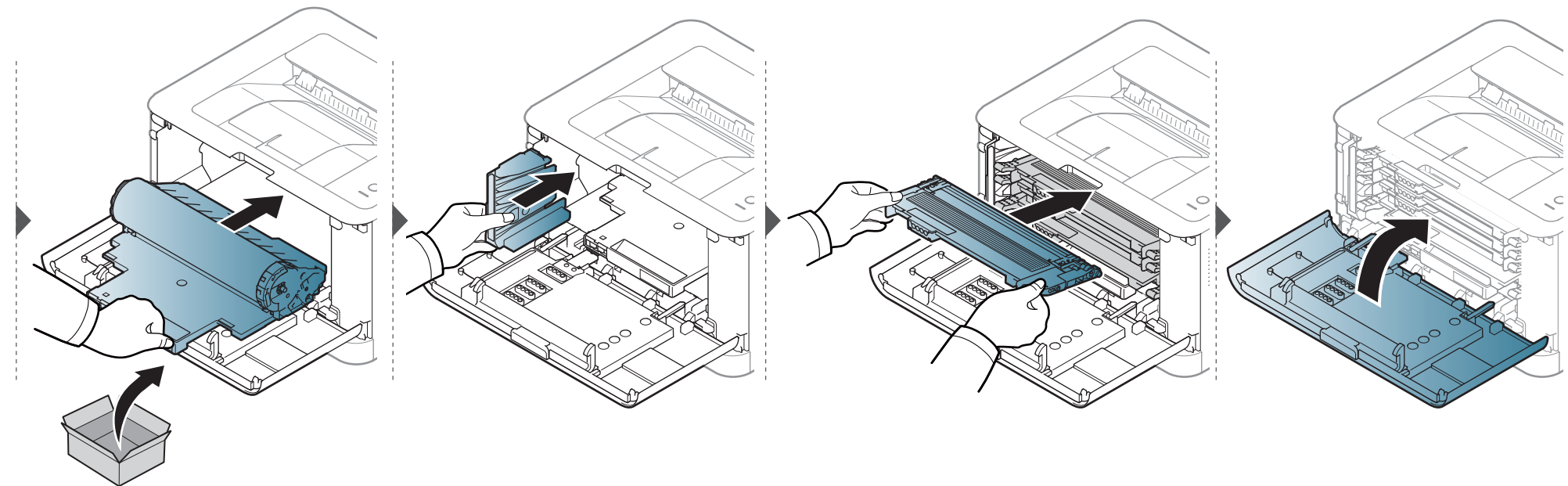
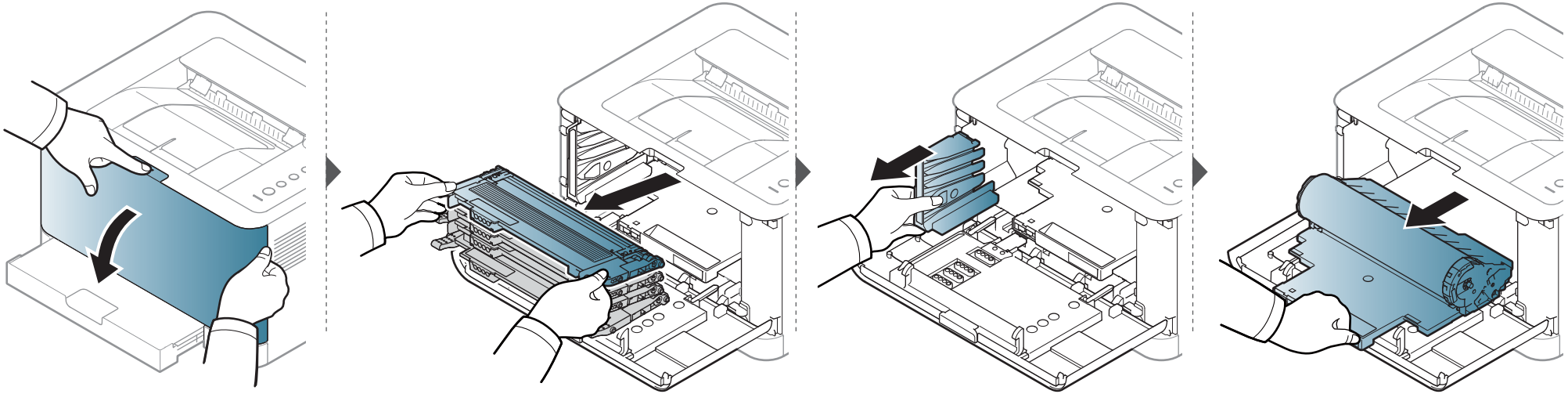

Cleaning the machine

If printing quality problems occur or if you use your machine in a dusty environment, you need to clean your machine regularly to keep it in the best printing condition and use your machine longer.



- Cleaning the cabinet of the machine with cleaning materials containing large amounts of alcohol, solvents, or other strong substances can discolor or distort the cabinet.
- If your machine or the surrounding area is contaminated with toner, we recommend you use a cloth or tissue dampened with water to clean it. If you use a vacuum cleaner, toner blows in the air and might be harmful to you.
- During the printing process, paper, toner, and dust particles can accumulate inside the machine. This buildup can cause print quality problems, such as toner specks or smearing. Cleaning the inside of the machine clears and reduces these problems.

Cleaning the outside or the display screen

Clean the machine cabinet or the display screen with a soft, lint-free cloth. Dampen the cloth slightly with water, but be careful not to let any water drip onto or into the machine.

Cleaning the inside

During the printing process, paper, toner, and dust particles can accumulate inside the machine. This buildup can cause print quality problems, such as toner specks or smearing. Cleaning the inside of the machine clears and reduces these problems.

Cleaning the machine



- Use a dry lint-free cloth to clean the machine.
- If your machine has a power switch, turn the power switch off before cleaning the machine.
- Before opening the top cover, close the output support first.

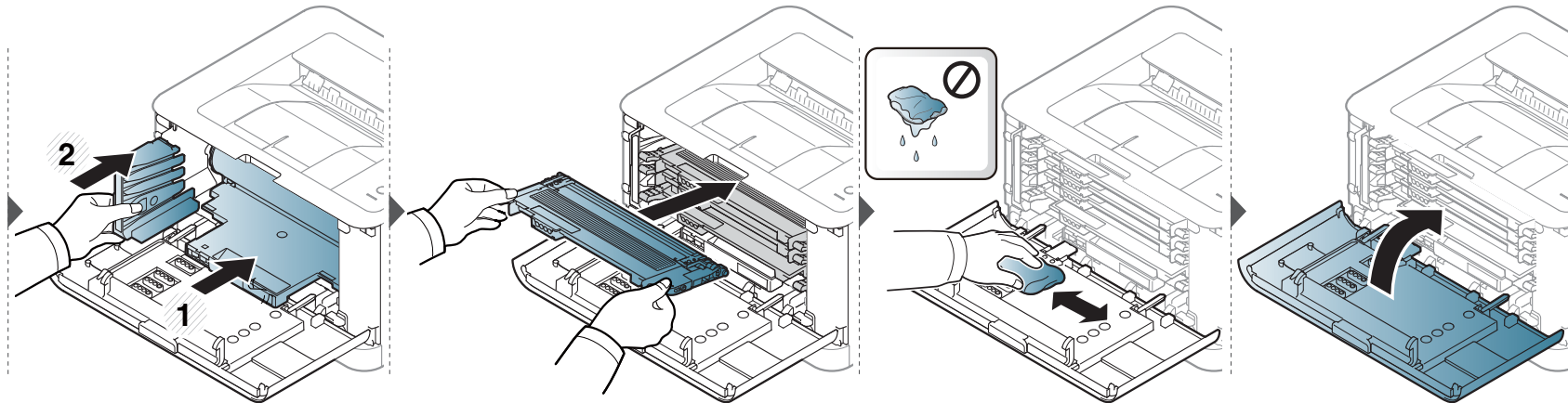
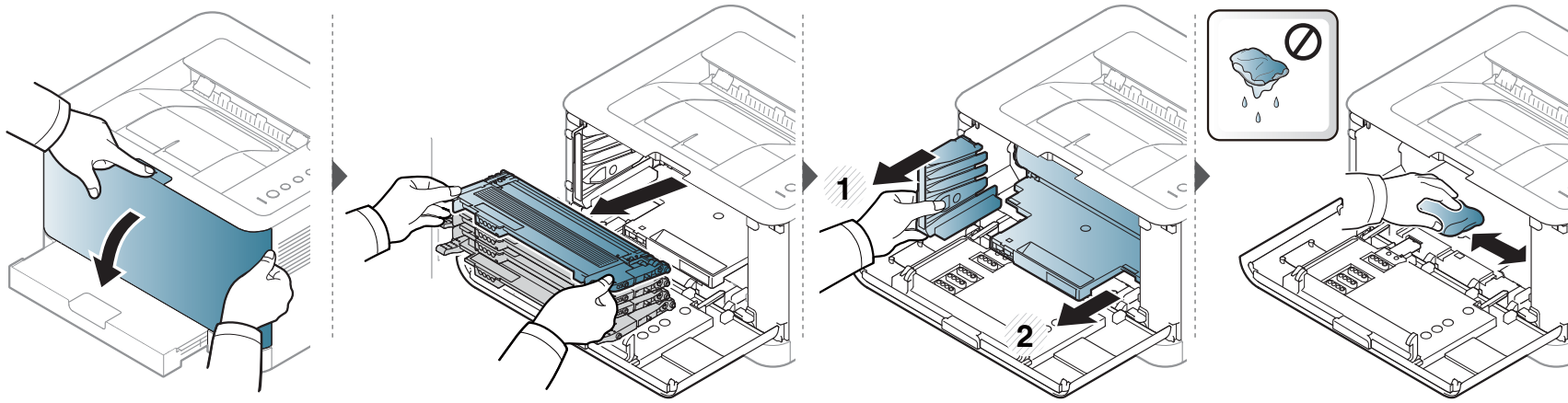

Tips for moving & storing your machine

- When moving the machine, do not tilt or turn it upside down. Otherwise, the inside of the machine may be contaminated by toner, which can cause damage to the machine or reduce print quality.
- When moving the machine, make sure at least two people are holding the machine securely.



4. Troubleshooting

This chapter gives helpful information for what to do if you encounter an error.

- **Tips for avoiding paper jams** 59
- **Clearing paper jams** 60
- **Understanding the status LED** 63



This chapter gives helpful information for what to do if you encounter an error.

If your machine has a display screen, check the message on the display screen first to solve the error. If you cannot find a solution to your problem in this chapter, refer to the **Troubleshooting** chapter in the Advanced User's Guide (see "Troubleshooting" on page 174).

If you cannot find a solution in the User's Guide or the problem persists, call for service.

Tips for avoiding paper jams

By selecting the correct media types, most paper jams can be avoided. To avoid paper jams, refer to the following guidelines:

- Ensure that the adjustable guides are positioned correctly (see "Tray overview" on page 28).
- Do not overload the tray. Ensure that the paper level is below the paper capacity mark on the inside of the tray.
- Do not remove paper from the tray while your machine is printing.
- Flex, fan, and straighten paper before loading.
- Do not use creased, damp, or highly curled paper.
- Do not mix paper types in a tray.
- Use only recommended print media (see "Print media specifications" on page 70).
- Perforated or embossed paper does not separate easily. Flex the sheets back and forth to loosen them, and fan them. Feed single paper from tray if there are multi-feeds or paper jams.
- Grain refers to the alignment of the paper fibers in a sheet of paper. Grain long paper is recommended.
- Do not use rough-edged paper.

Clearing paper jams

 To avoid tearing the paper, pull the jammed paper out slowly and gently.

In tray

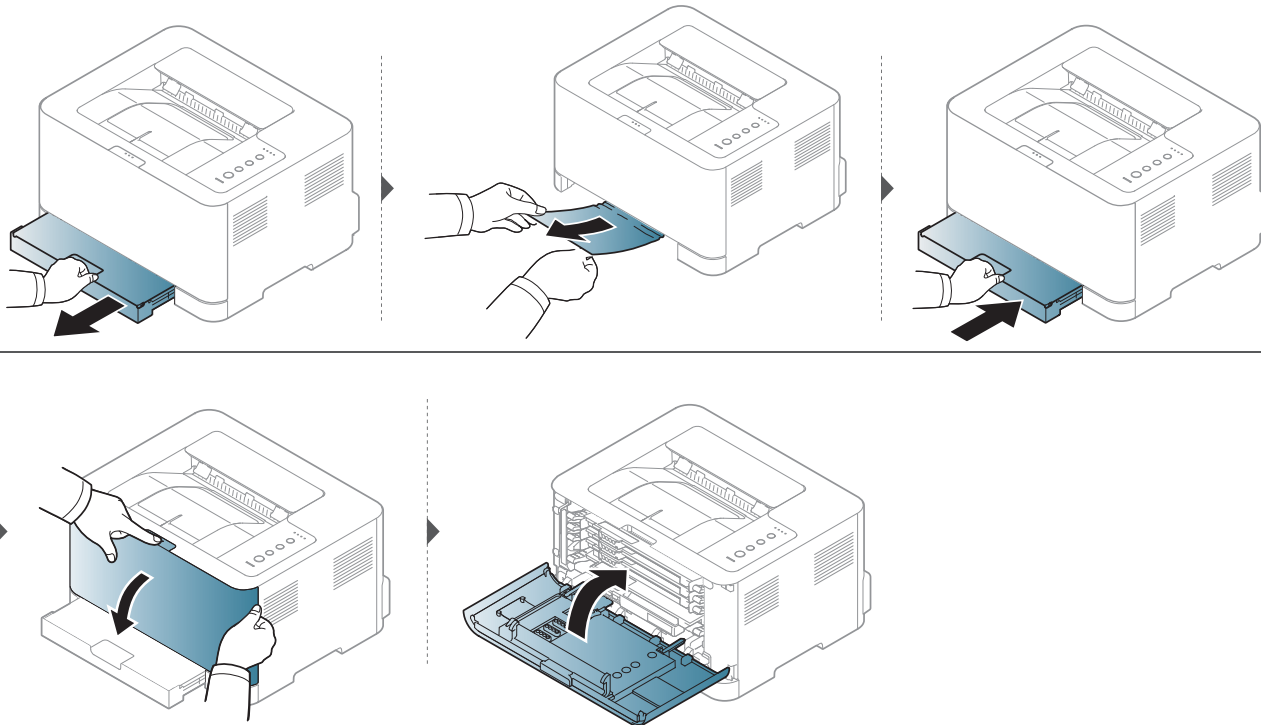

Clearing paper jams

Inside the machine



The fuser area is hot. Take care when removing paper from the machine.

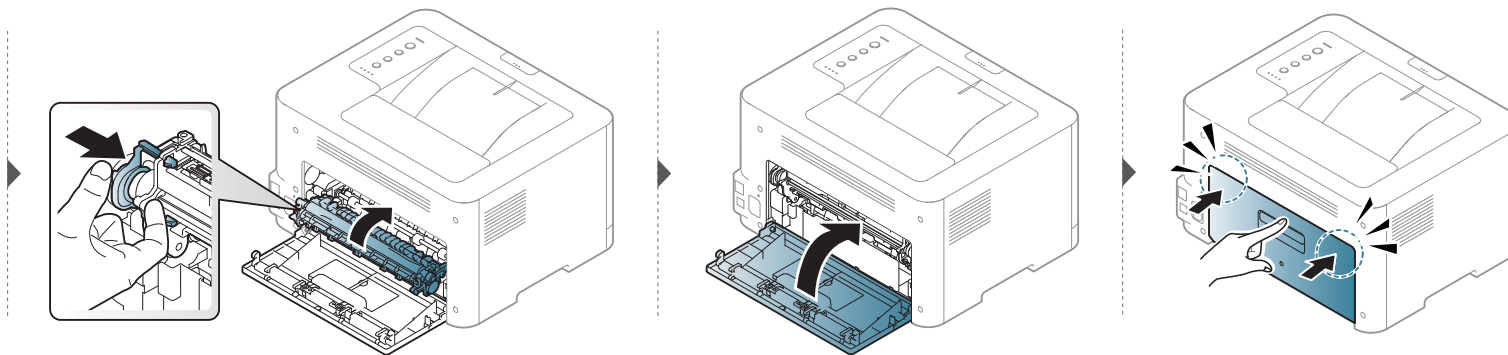
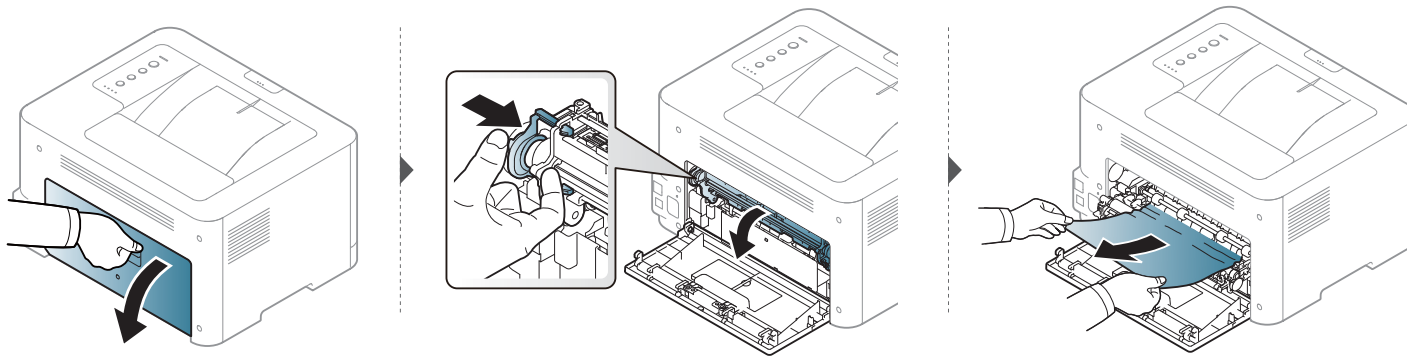

Clearing paper jams

In exit area



The fuser area is hot. Take care when removing paper from the machine.

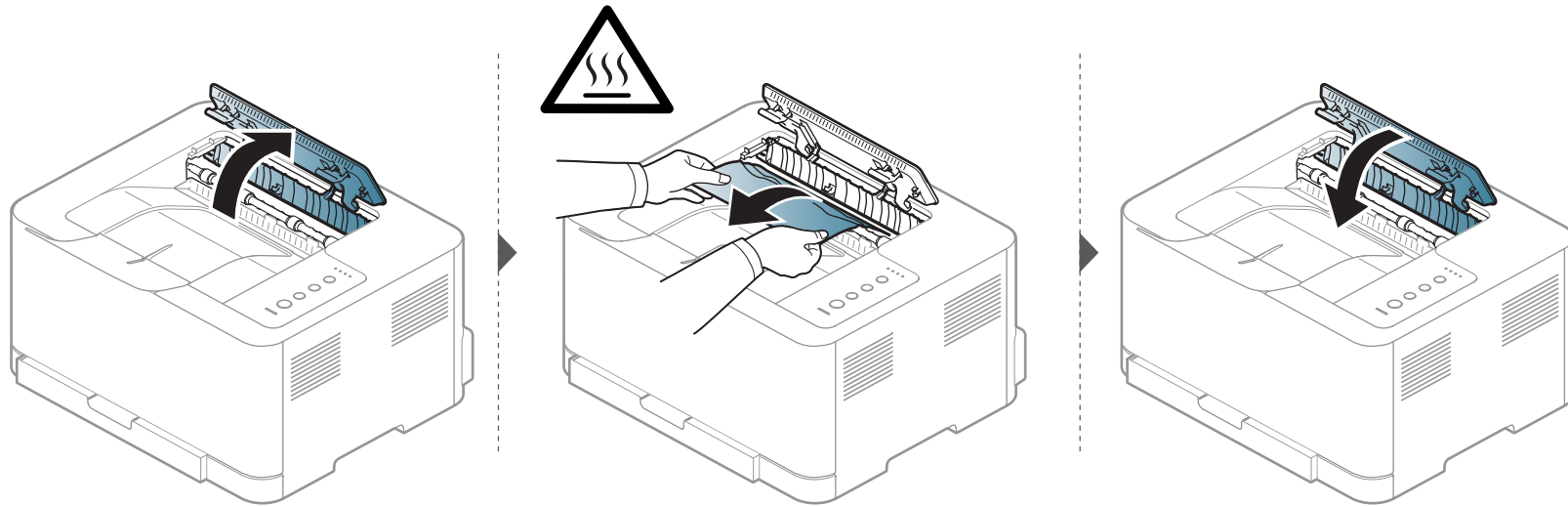

Understanding the status LED

The color of the LED indicates the machine's current status.



- Some LEDs may not be available depending on model or country (see "Control panel overview" on page 20).
- To resolve the error, look at the error message and its instructions from the troubleshooting part (see "Troubleshooting" on page 174).
- You also can resolve the error with the guideline from the computer's Samsung Printing Status program window (see "Using Samsung Printer Status" on page 166).
- If the problem persists, call a service representative.

Understanding the status LED



Status LED

The color of the status LED indicates the machine's current status.

Status		Description	
 (Status LED)	Off	<ul style="list-style-type: none">The machine is off-line.The machine is in power saver mode. When data is received, or any button is pressed, it switches to on-line automatically.	
	Blue	On	The machine is on-line and can be used.
		Blinking	<ul style="list-style-type: none">When the status LED slowly blinks, the machine is receiving data from the computer.When the status LED blinks rapidly, the machine is printing data.
	Orange	On	<ul style="list-style-type: none">A paper jam has occurred (see "Clearing paper jams" on page 60).The door is open. Close the door.There is no paper in the tray. Load paper in the tray (see "Loading paper in the tray" on page 29).The machine has stopped due to a major error.The waste toner container is not installed in the machine, or the waste toner container is full (see "Replacing the waste toner container" on page 51).An imaging unit has almost reached its estimated cartridge life. It is recommended to replace the imaging unit.
		Blinking	A minor error has occurred and the machine is waiting for the error to be cleared. When the problem is cleared, the machine resumes its original task.

Understanding the status LED

Toner / Status LED

 (Toner LED)		 (Status LED)		Description
Orange	Off	Blue	On	All toner cartridges are at normal capacity.
	Blinking	Blue	On	Small amount of toner is left in the cartridge. The estimated cartridge life of toner is close. Prepare a new cartridge for replacement. You may temporarily increase the printing quality by redistributing the toner (see "Redistributing toner" on page 47). ^a
	On	Blue	On	The toner cartridge life ^b is totally empty. Remove the old toner cartridge and install a new one.
	On	Orange	On	<ul style="list-style-type: none">A toner cartridge has almost reached its estimated cartridge life^c. It is recommended to replace the toner cartridge (see "Replacing the toner cartridge" on page 49).The toner cartridge is not installed or the wrong toner cartridge is installed (see "Replacing the toner cartridge" on page 49).



a. Some LEDs may not be available depending on model or country(see "Control panel overview" on page 20).

b. Estimated cartridge life means the expected or estimated toner cartridge life, which indicates the average capacity of print-outs and is designed pursuant to ISO/IEC 19798. The number of pages may be affected by operating environment, printing interval, media type, and media size. Some amount of toner may remain in the cartridge even when the orange LED is on and the printer stops printing.

c. Estimated cartridge life means the expected or estimated toner cartridge life, which indicates the average capacity of print-outs and is designed pursuant to ISO/IEC 19798. The number of pages may be affected by operating environment, printing interval, graphics, media type and media size. Some amount of toner may remain in the cartridge even when orange LED is on and the printer stops printing.

Understanding the status LED

WPS / Power / Eco LED

Status		Description	
 (WPS LED) ^a	Blue	Blinking	The machine is connecting to a wireless network.
		On	The machine is connected to a wireless network (see "Using the WPS button" on page 110).
		Off	The machine is disconnected from a wireless network.
 (Power/Wake Up LED)	Blue	On	The machine is in power save mode.
		Off	The machine is in ready mode or the machine's power is off.
Eco	Green	On	Eco mode is on (see "Eco printing" on page 39).
		Off	Eco mode is off.

a. Wireless model only (see "Features by model" on page 6).



5. Appendix

This chapter provides product specifications and information concerning applicable regulations.

- **Specifications** 68
- **Regulatory information** 77
- **Copyright** 88

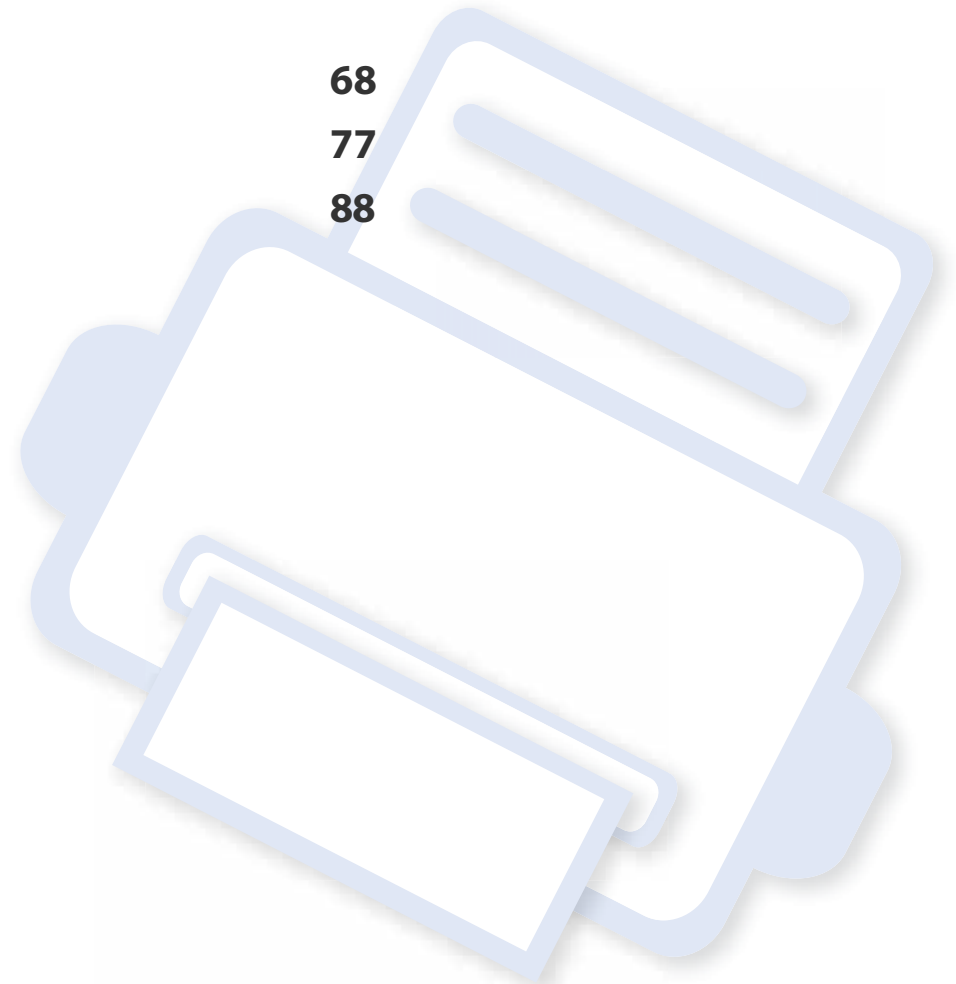

Specifications

General specifications



These specifications are subject to change without notice. To see additional specifications and information about changes to the specifications, please visit www.samsung.com.

Items		Description
Dimension^a	Width x Length x Height	382 x 309 x 211 mm (15.0 x 12.2 x 8.3 inches)
Weight^a	Machine with consumables	9.96 kg (21.96 lbs)
Noise Level^{bc}	Ready mode	Background noise level
	Print mode	<ul style="list-style-type: none">• Color printing: Less than 46 dB (A)• Black and white printing: Less than 48 dB (A)
Temperature	Operation	10 to 30°C (50 to 86°F)
	Storage (packed)	-20 to 40°C (-4 to 104°F)
Humidity	Operation	20 to 80% RH
	Storage (packed)	10 to 90% RH
Power rating^d	110 volt models	AC 110 - 127 V
	220 volt models	AC 220 - 240 V

Specifications

Items		Description
Power consumption ^e	Average operating mode	Less than 290W
	Ready mode	Less than 60 W
	Power save mode	Less than 1.4 W
	Power off mode ^f	0.45 W
	Network Standby Mode (All Port Activation)	Less than 1.1 W
Wireless ^g	Module	SPW-B43143S

a. Dimensions and weight are measured without other accessories.

b. Sound Pressure Level, ISO 7779. Configuration tested: basic machine installation, A4 paper, simplex printing.

c. China only: If the equipment's noise is louder than 63 db (A), the equipment should be placed in region of relatively independent advice.

d. See the rating label on the machine for the correct voltage (V), frequency (hertz) and type of current (A) for your machine.

e. The power consumption may be affected by the machine's status, setting conditions, operating environment, and measuring equipment and method the country uses.

f. Power consumption can be completely avoided only when power cable is not connected.

g. Wireless model only (see "Features by model" on page 6).

Specifications

Print media specifications

Type	Size	Dimensions	Print media weight/Capacity ^a
			Tray
Plain paper	Letter	216 x 279 mm (8.5 x 11 inches)	60 to 85 g/m ² (16 to 23 lbs bond)
	Legal	216 x 356 mm (8.5 x 14 inches)	<ul style="list-style-type: none"> 150 sheets of 75 g/m² (20 lbs bond) Maximum stack height : 15.5mm (0.6 inches)
	US Folio	216 x 330 mm (8.5 x 13 inches)	
	A4	210 x 297 mm (8.27 x 11.69 inches)	
	Oficio	216 x 343 mm (8.5 x 13.5 inches)	
	JIS B5	182 x 257 mm (7.17 x 10.12 inches)	
	ISO B5	176 x 250 mm (6.93 x 9.84 inches)	
	Executive	184 x 267 mm (7.25 x 10.5 inches)	
	A5	148 x 210 mm (5.83 x 8.27 inches)	
	A6	105 x 148 mm (4.13 x 5.83 inches)	
Thick paper	Refer to the Plain paper section	Refer to the Plain paper section	86 to 120 g/m ² (23 to 32 lbs bond) <ul style="list-style-type: none"> 5 sheets
Thin paper	Refer to the Plain paper section	Refer to the Plain paper section	60 to 70 g/m ² (16 to 19 lbs bond) <ul style="list-style-type: none"> 150 sheets of 60 g/m² (16 lbs bond) Maximum stack height : 15.5mm (0.6 inches)

Specifications

Type	Size	Dimensions	Print media weight/Capacity ^a
			Tray
Cotton	Refer to the Plain paper section	Refer to the Plain paper section	75 to 90 g/m ² (20 to 24 lbs bond) <ul style="list-style-type: none"> • 150 sheets of 75 g/m² (20 lbs bond) • Maximum stack height : 15.5mm (0.6 inches)
Colored, Pre-printed, Recycled	Refer to the Plain paper section	Refer to the Plain paper section	60 to 85 g/m ² (16 to 24 lbs bond) <ul style="list-style-type: none"> • 150 sheets of 75 g/m² (20 lbs bond) • Maximum stack height : 15.5mm (0.6 inches)
Labels^b	Letter, Legal, Oficio, US Folio, A4, JIS B5, ISO B5, Executive, A5	Refer to the Plain paper section	120 to 150 g/m ² (32 to 40 lbs bond) <ul style="list-style-type: none"> • 5 sheets
Card stock	Letter, Legal, Oficio, US Folio, A4, JIS B5, ISO B5, Executive, A5, Postcard 4x6	Refer to the Plain paper section	121 to 163 g/m ² (32 to 43 lbs bond) <ul style="list-style-type: none"> • 5 sheets
Bond paper	Refer to the Plain paper section	Refer to the Plain paper section	105 to 120 g/m ² (28 to 32 lbs bond) <ul style="list-style-type: none"> • 10 sheets
Archive	Refer to the Plain paper section	Refer to the Plain paper section	70 to 90 g/m ² (18.6 to 24 lbs bond) <ul style="list-style-type: none"> • 100 sheets • Maximum stack height : 15.5mm (0.6 inches)

Specifications

Type	Size	Dimensions	Print media weight/Capacity ^a
			Tray
Glossy Photo, Matte Photo	Letter, A4, Postcard 4x6	Refer to the Plain paper section	111 to 220 g/m ² (30 to 58 lbs bond) • 1 sheets
Minimum size (custom)		76 x 152 mm (3 x 6 inches)	60 to 120 g/m ² (16 to 32 lbs bond)
Maximum size (custom)		216 x 356 mm (8.5 x 14 inches)	

a. Maximum capacity may differ depending on media weight, thickness, and environmental conditions.

b. The smoothness of the labels used in this machine is 100 to 250 (sheffield). This means the numeric level of smoothness.

 If media weight is over 120 g/m² (32 lbs bond), load a paper into the tray one by one.

Specifications

System requirements

Microsoft® Windows®

Operating system	Requirement (recommended)		
	CPU	RAM	free HDD space
Windows® XP Service Pack 3	Intel® Pentium® III 1 GHz (Pentium IV 2 GHz)	512 MB (1 GB)	1.5 GB
Windows Server® 2003	Intel® Pentium® III 1 GHz (Pentium IV 2 GHz)	512 MB (1 GB)	1.5 GB
Windows Server® 2008	Intel® Pentium® IV 1 GHz (Pentium IV 2 GHz)	512 MB (2 GB)	10 GB
Windows Vista®	Intel® Pentium® IV 3 GHz	512 MB (1 GB)	15 GB
Windows® 7	Intel® Pentium® IV 1 GHz 32-bit or 64-bit processor or higher	1 GB (2 GB)	16 GB
	<ul style="list-style-type: none"> • Support for DirectX® 9 graphics with 128 MB memory (to enable the Aero theme). • DVD-R/W Drive 		
Windows Server® 2008 R2	Intel® Pentium® IV 1.4 GHz (x64) processors (2 GHz or faster)	512 MB (2 GB)	10 GB
Windows® 8 Windows® 8.1 Windows® 10 Windows Server® 2016	Intel® Pentium® IV 1 GHz 32-bit or 64-bit processor or higher	2 GB (2 GB)	20 GB
	<ul style="list-style-type: none"> • Support for DirectX® 9 graphics with 128 MB memory (to enable the Aero theme). • DVD-R/W Drive 		
Windows Server® 2012 Windows Server® 2012 R2	Intel® Pentium® IV 1.4 GHz (x64) processors (2 GHz or faster)	512 MB (2 GB)	32GB

Specifications



- Internet Explorer 6.0 or higher is the minimum requirement for all Windows operating systems.
- Users who have administrator rights can install the software.
- **Windows Terminal Services** is compatible with your machine.

Mac

Operating system	Requirements (Recommended)		
	CPU	RAM	Free HDD space
Mac OS X 10.6	• Intel® processors	1 GB (2 GB)	1 GB
Mac OS X 10.7-10.10	• Intel® processors	2 GB	4 GB

Specifications

Linux

Items	Requirements
Operating system	Redhat® Enterprise Linux 5, 6,7 Fedora 12, 13, 14, 15, 16, 17, 18, 19, 20 OpenSuSE® 11.2, 11.3, 11.4, 12.1, 12.2, 12.3, 13.1 Ubuntu 10.04, 10.10, 11.04, 11.10, 12.04, 12.10, 13.04, 13.10, 14.04 SuSE Linux Enterprise Desktop 10, 11 Debian 6, 7 Mint 13, 14, 15, 16, 17
CPU	Pentium IV 2.4GHz (Intel Core™2)
RAM	512 MB (1 GB)
Free HDD space	1 GB (2 GB)

Specifications

Network environment



Network and wireless models only (see "Features by model" on page 6).

You need to set up the network protocols on the machine to use it as your network machine. The following table shows the network environments supported by the machine.

Items	Specifications
Network interface	<ul style="list-style-type: none">• Ethernet 10/100 Base-TX Wired Lan• 802.11b/g/n Wireless LAN
Network operating system	<ul style="list-style-type: none">• Windows® XP Service Pack 3, Windows Server® 2003, Windows Vista®, Windows® 7, Windows® 8, Windows Server® 2008 R2• Various Linux OS• Mac OS X 10.6 - 10.10
Network protocols	<ul style="list-style-type: none">• TCP/IPv4• DHCP, BOOTP• DNS, WINS, Bonjour, SLP, UPnP• Standard TCP/IP Printing (RAW), LPR, IPP, WSD• SNMPv 1/2/3, HTTP• TCP/IPv6 (DHCP, DNS, RAW, LPR, SNMPv 1/2/3, HTTP)
Wireless security	<ul style="list-style-type: none">• Authentication: Open System, Shared Key, WPA Personal, WPA2 Personal (PSK)• Encryption: WEP64, WEP128, TKIP, AES

Regulatory information

This machine is designed for a normal work environment and certified with several regulatory statements.

Laser safety statement

The printer is certified in the U.S. to conform to the requirements of DHHS 21 CFR, chapter 1 Subchapter J for Class I (1) laser products, and elsewhere is certified as a Class I laser product conforming to the requirements of IEC 60825-1 : 2007.

Class I laser products are not considered to be hazardous. The laser system and printer are designed so there is never any human access to laser radiation above a Class I level during normal operation, user maintenance or prescribed service condition.

Warning

Never operate or service the printer with the protective cover removed from laser/scanner assembly. The reflected beam, although invisible, can damage your eyes.

When using this product, these basic safety precautions should always be followed to reduce risk of fire, electric shock, and injury to persons:

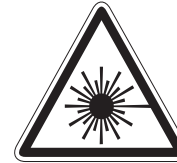

CAUTION - CLASS 3B. INVISIBLE LASER RADIATION WHEN OPEN. AVOID EXPOSURE TO THE BEAM.

ATTENTION - CLASSE 3B. RADIATION LASER INVISIBLE EN CAS D'OUVERTURE. EVITER L'EXPOSITION AU FAISCEAU.

GEFAHREN - KLASSE 3B: UNSICHTBARE LASERSTRAHLUNG WENN GEOFFNET. STRAHLENAUSSETZUNG VERMEIDEN.

ATTENZIONE - CLASSE 3B. RADIAZIONI LASER INVISIBILI CON IL DISPOSITIVO APERTO. EVITARE L'ESPOSIZIONE AL RAGGIO.

PRECAUCIÓN - RADIACIÓN LÁSER INVISIBLE DE CLASE 3B PRESENTE AL ABRIR. EVITE LA EXPOSICIÓN AL HAZ.

PERIGO - CLASSE 3B. RADIAÇÃO LASER INVISÍVEL AO ABRIR. EVITE EXPOSIÇÃO DIRECTA AO FEIXE.

GEVAAR - KLASSE 3B. ONZICHTBARE LASERSTRALING INDIEN GEOPEND. VERMIJD BLOOTSTELLING AAN DE STRAAL.

ADVARSEL - KLASSE 3B. USYNLIG LASERSTRÅLING VED ÅBNING. UNNGÅ UDSÆTTELSE FOR STRÅLING.

ADVARSEL - KLASSE 3B. USYNLIG LASERSTRÅLING NÅR DEKSEL ÅPNES. UNNGÅ EKSPONERING FOR STRÅLEN.

VARNING - KLASS 3B OSYNLIG LASERSTRÅLNING NÅR DENNA DEL ÅR ÖPPNAD. STRÅLEN ÅR FARLIG.

VAROITUS - LUOKAN 3B NÄKYMÄTTÖMÄLLE LASER-SÄTEILYÄ AVATTUNA. VÄLTÄ ALTISTUMISTA SÄTEELLE.

注意 - CLASS 3B。严禁打开, 以免被不可见激光辐射 泄漏灼伤

주의 - 열리면 등급 3B 비가시 레이저 방사선이 방출됩니다. 광선에 노출을 피하십시오.

注意 - CLASS 3B。嚴禁打開, 以免被不可見激光輻射洩漏灼傷

Regulatory information

Ozone safety



This product's ozone emission rate is under 0.1 ppm. Because ozone is heavier than air, keep the product in a place with good ventilation.

Perchlorate warning

This Perchlorate warning applies only to primary CR (Manganese Dioxide) Lithium coin cells in the product sold or distributed ONLY in California USA.

Perchlorate Material - special handling may apply.

See www.dtsc.ca.gov/hazardouswaste/perchlorate. (U.S.A. only)

Power saver



This printer contains advanced energy conservation technology that reduces power consumption when it is not in active use.

When the printer does not receive data for an extended period of time, power consumption is automatically lowered.

ENERGY STAR and the ENERGY STAR mark are registered U.S. marks.

For more information on the ENERGY STAR program see <http://www.energystar.gov>

For ENERGY STAR certified models, the ENERGY STAR label will be on your machine. Check if your machine is ENERGY STAR certified.

Recycling



Recycle or dispose of the packaging material for this product in an environmentally responsible manner.

Regulatory information

Correct disposal of this product (Waste electrical & electronic equipment)

(Applicable in countries with separate collection systems)



This marking on the product, accessories or literature indicates that the product and its electronic accessories (e.g. charger, headset, USB cable) should not be disposed of with other household waste at the end of their working life. To prevent possible harm to the environment or human health from uncontrolled waste disposal, please separate these items from other s of waste and recycle them responsibly to promote the sustainable reuse of material resources.

Household users should contact either the retailer where they purchased this product, or their local government office, for details of where and how they can take these items for environmentally safe recycling.

Business users should contact their supplier and check the terms and conditions of the purchase contract. This product and its electronic accessories should not be mixed with other commercial wastes for disposal.

(The United States of America only)

Dispose unwanted electronics through an approved recycler. To find the nearest recycling location, go to our website: www.samsung.com/recyclingdirect Or call, (877) 278 - 0799

EU REACH SVHC Declaration

For information on Samsung's environmental commitments and product specific regulatory obligations e.g. REACH visit: www.samsung.com/uk/aboutsamsung/samsungelectronics/corporatecitizenship/data_corner.html

State of California Proposition 65 Warning (US Only)

The California Safe Drinking Water and Toxic Enforcement Act requires the Governor of California to publish a list of chemicals known to the state of California to cause cancer or reproductive toxicity and requires businesses to warn of exposure to such chemicals.

WARNING: This product contains chemicals known to the State of California to cause cancer and birth defects or other reproductive harm. This appliance and its accessories can cause low-level exposure to chemicals during operation, which can be reduced by operating the appliance in a well ventilated area, and low-level exposure to chemicals through other use or handling.

Regulatory information

Radio frequency emissions

FCC information to the user

This device complies with Part 15 of the FCC Rules. Operation is subject to the following two conditions:

- This device may not cause harmful interference, and
- This device must accept any interference received, including interference that may cause undesired operation.

This equipment has been tested and found to comply with the limits for a Class B digital device, pursuant to Part 15 of the FCC Rules. These limits are designed to provide reasonable protection against harmful interference in a residential installation. This equipment generates, uses and can radiate radio frequency energy and, if not installed and used in accordance with the instructions, may cause harmful interference to radio communications. However, there is no guarantee that interference will not occur in a particular installation. If this equipment does cause harmful interference to radio or television reception, which can be determined by turning the equipment off and on, the user is encouraged to try to correct the interference by one or more of the following measures:

- Reorient or relocate the receiving antenna.
- Increase the separation between the equipment and receiver.
- Connect the equipment into an outlet on a circuit different from that to which the receiver is connected.
- Consult the dealer or experienced radio TV technician for help.



Change or modifications not expressly approved by the manufacturer responsible for compliance could void the user's authority to operate the equipment.

Canadian radio interference regulations

This digital apparatus does not exceed the Class B limits for radio noise emissions from digital apparatus as set out in the interference-causing equipment standard entitled "Digital Apparatus", ICES-003 of the Industry and Science Canada.

Cet appareil numérique respecte les limites de bruits radioélectriques applicables aux appareils numériques de Classe B prescrites dans la norme sur le matériel brouilleur: "Appareils Numériques", ICES-003 édictée par l'Industrie et Sciences Canada.

RFID (Radio Frequency Interface Device)

RFID operation is subject to the following two conditions:(1) this device may not cause interference, and (2) this device must accept any interference, including interference that may cause undesired operation of the device. (U.S.A., France, Taiwan only)

Regulatory information

United States of America

Federal Communications Commission (FCC)

Intentional emitter per FCC Part 15

Low power, Radio LAN devices (radio frequency (RF) wireless communication devices), operating in the 2.4 GHz/5 GHz Band, may be present (embedded) in your printer system. This section is only applicable if these devices are present. Refer to the system label to verify the presence of wireless devices.

Wireless devices that may be in your system are only qualified for use in the United States of America if an FCC ID number is on the system label.

The FCC has set a general guideline of 20 cm (8 inches) separation between the device and the body, for use of a wireless device near the body (this does not include extremities). This device should be used more than 20 cm (8 inches) from the body when wireless devices are on. The power output of the wireless device (or devices), which may be embedded in your printer, is well below the RF exposure limits as set by the FCC.

This transmitter must not be collocated or operation in conjunction with any other antenna or transmitter.

Operation of this device is subject to the following two conditions: (1) This device may not cause harmful interference, and (2) this device must accept any interference received, including interference that may cause undesired operation of the device.



Wireless devices are not user serviceable. Do not modify them in any way. Modification to a wireless device will void the authorization to use it. Contact manufacturer for service.

FCC Statement for Wireless LAN use:



While installing and operating this transmitter and antenna combination the radio frequency exposure limit of 1 mW/cm² may be exceeded at distances close to the antenna installed. Therefore, the user must maintain a minimum distance of 20 cm from the antenna at all times. This device cannot be collocated with another transmitter and transmitting antenna.

Replacing the Fitted Plug (for UK Only)

Important

The mains lead for this machine is fitted with a standard (BS 1363) 13 amp plug and has a 13 amp fuse. When you change or examine the fuse, you must re-fit the correct 13 amp fuse. You then need to replace the fuse cover. If you have lost the fuse cover, do not use the plug until you have another fuse cover.

Contact the people from you purchased the machine.

Regulatory information

The 13 amp plug is the most widely used in the UK and should be suitable. However, some buildings (mainly old ones) do not have normal 13 amp plug sockets. You need to buy a suitable plug adaptor. Do not remove the moulded plug.



If you cut off the moulded plug, get rid of it straight away.

You cannot rewire the plug and you may receive an electric shock if you plug it into a socket.

Important warning:

You must earth this machine.

The wires in the mains lead have the following color code:



- **Green and Yellow:** Earth
- **Blue:** Neutral
- **Brown:** Live

If the wires in the mains lead do not match the colors marked in your plug, do the following:

You must connect the green and yellow wire to the pin marked by the letter “E” or by the safety ‘Earth symbol’ or colored green and yellow or green.

You must connect the blue wire to the pin which is marked with the letter “N” or colored black.

You must connect the brown wire to the pin which is marked with the letter “L” or colored red.

You must have a 13 amp fuse in the plug, adaptor, or at the distribution board.

Declaration of conformity (European countries)

Approvals and Certifications

Hereby, Samsung Electronics, declares that this [C43x series] is in compliance with the essential requirements and other relevant provisions of Low Voltage Directive (2006/95/EC), EMC Directive (2004/108/EC).



Hereby, Samsung Electronics, declares that this [C43xW series] is in compliance with the essential requirements and other relevant provisions of R&TTE Directive 1999/5/EC.

The declaration of conformity may be consulted at www.samsung.com, go to Support > Download center and enter your printer (MFP) name to browse the EuDoC.

January 1, 1995: Council Directive 2006/95/EC Approximation of the laws of the member states related to low voltage equipment.

January 1, 1996: Council Directive 2004/108/EC, approximation of the laws of the Member States related to electromagnetic compatibility.

Regulatory information

March 9, 1999: Council Directive 1999/5/EC on radio equipment and telecommunications terminal equipment and the mutual recognition of their conformity. A full declaration, defining the relevant Directives and referenced standards can be obtained from your Samsung Electronics Co., Ltd. representative.

EC Certification

Certification to 1999/5/EC Radio Equipment & Telecommunications Terminal Equipment Directive (FAX)

This Samsung product has been self-certified by Samsung for pan-European single terminal connection to the analogue public switched telephone network (PSTN) in accordance with Directive 1999/5/EC. The product has been designed to work with the national PSTNs and compatible PBXs of the European countries:

In the event of problems, you should contact the Euro QA Lab of Samsung Electronics Co., Ltd. in the first instance.

The product has been tested against TBR21. To assist in the use and application of terminal equipment which complies with this standard, the European Telecommunication Standards Institute (ETSI) has issued an advisory document (EG 201 121) which contains notes and additional requirements to ensure network compatibility of TBR21 terminals. The product has been designed against, and is fully compliant with, all of the relevant advisory notes contained in this document.

European radio approval information (for products fitted with EU-approved radio devices)

Low power, Radio LAN type devices (radio frequency (RF) wireless communication devices), operating in the 2.4 GHz/5 GHz band, may be present (embedded) in your printer system which is intended for home or office use. This section is only applicable if these devices are present. Refer to the system label to verify the presence of wireless devices.



Wireless devices that may be in your system are only qualified for use in the European Union or associated areas if a CE mark with a Notified Body Registration Number and the Alert Symbol is on the system label.

The power output of the wireless device or devices that may be embedded in your printer is well below the RF exposure limits as set by the European Commission through the R&TTE directive.

European states qualified under wireless approvals:

EU countries

European states with restrictions on use:

EU

In France, this equipment may only be used indoors.

EEA/EFTA countries

Regulatory information

No limitations at this time

Regulatory compliance statements

Wireless guidance

Low power, Radio LAN devices (radio frequency (RF) wireless communication devices), operating in the 2.4 GHz/5 GHz Band, may be present (embedded) in your printer system. The following section is a general overview of considerations while operating a wireless device.

Additional limitations, cautions, and concerns for specific countries are listed in the specific country sections (or country group sections). The wireless devices in your system are only qualified for use in the countries identified by the Radio Approval Marks on the system rating label. If the country you will be using the wireless device in, is not listed, contact your local Radio Approval agency for requirements. Wireless devices are closely regulated and use may not be allowed.

The power output of the wireless device or devices that may be embedded in your printer is well below the RF exposure limits as known at this time. Because the wireless devices (which may be embedded into your printer) emit less energy than is allowed in radio frequency safety standards and recommendations, manufacturer believes these devices are safe for use. Regardless of the power levels, care should be taken to minimize human contact during normal operation.

As a general guideline, a separation of 20 cm (8 inches) between the wireless device and the body, for use of a wireless device near the body (this does not include extremities) is typical. This device should be used more than 20 cm (8 inches) from the body when wireless devices are on and transmitting.

This transmitter must not be collocated or operation in conjunction with any other antenna or transmitter.

Some circumstances require restrictions on wireless devices. Examples of common restrictions are listed below:



Radio frequency wireless communication can interfere with equipment on commercial aircraft. Current aviation regulations require wireless devices to be turned off while traveling in an airplane. IEEE 802.11 (also known as wireless Ethernet) and Bluetooth communication devices are examples of devices that provide wireless communication.



In environments where the risk of interference to other devices or services is harmful or perceived as harmful, the option to use a wireless device may be restricted or eliminated. Airports, Hospitals, and Oxygen or flammable gas laden atmospheres are limited examples where use of wireless devices may be restricted or eliminated. When in environments where you are uncertain of the sanction to use wireless devices, ask the applicable authority for authorization prior to use or turning on the wireless device.

Regulatory information



Every country has different restrictions on the use of wireless devices. Since your system is equipped with a wireless device, when traveling between countries with your system, check with the local Radio Approval authorities prior to any move or trip for any restrictions on the use of a wireless device in the destination country.



If your system came equipped with an internal embedded wireless device, do not operate the wireless device unless all covers and shields are in place and the system is fully assembled.



Wireless devices are not user serviceable. Do not modify them in any way. Modification to a wireless device will void the authorization to use it. Contact manufacturer for service.



Only use drivers approved for the country in which the device will be used. See the manufacturer System Restoration Kit, or contact manufacturer Technical Support for additional information.

Taiwan only

警告

本電池如果更換不正確會有爆炸的危險
請依製造商說明書處理用過之電池

Taiwan only

低功率電波輻射性電機管理辦法

第十二條 經型式認證合格之低功率射頻電機，非經許可，公司、商號或使用者均不得擅自變更頻率、加大功率或變更原設計之特性及功能。

第十四條 低功率射頻電機之使用不得影響飛航安全及干擾合法通信；經發現有干擾現象時，應立即停用，並改善至無干擾時方得繼續使用。前項合法通信，指依電信法規定作業之無線電通信。低功率射頻電機須忍受合法通信或工業、科學及醫療用電波輻射性電機設備之干擾。

Russia / Kazakhstan / Belarus only



Изготовитель: «Самсунг Электроникс Ко., Лтд.»
(Мэтан-донг) 129, Самсунг-ро, Енгтонг-гу, г. Сувон, Кёнги-до, Республика Корея

Импортер: ООО «Самсунг Электроникс Рус Компани»
Адрес: 125009, г. Москва, ул. Воздвиженка 10

Самсунг Электроникс Ко. Лтд
(Мэтан-донг) 129, Самсунг-ро, Енгтонг-гу, Сувон қ., Кёнги-до, Корея Республикасы
«САМСУНГ ЭЛЕКТРОНИКС КЗ ЭНД ЦЕНТРАЛ ЭЙЖА» ЖШС
Заңды мекен-жайы: Қазақстан Республикасы, Алматы қ., Өл-Фараби даңғылы, 36, 3,4-қабаттар

Regulatory information

Germany only

Das Gerät ist nicht für die Benutzung am Bildschirmarbeitsplatz gemäß Bildschirmarbeitsverordnung vorgesehen.

Das Gerät kann der Bildschirmarbeitsverordnung unterliegen und in diesem Zusammenhang Abweichungen von an Bildschirmarbeitsplätze zu stellenden Anforderungen (Zeichengröße auf Bildschirmgerät und Tastatur) aufweisen. Es ist daher für Tätigkeiten nicht geeignet, bei denen Beschäftigte das Gerät für einen nicht unwesentlichen Teil ihrer normalen Arbeit mit Bildschirmarbeit benutzen.

Bei Aufstellung des Gerätes darauf achten, dass Blendungen durch in der Anzeige spiegelnde Lichtquellen vermieden werden.

Turkey only

- Bu ürünün ortalama yaşam süresi 7 yıl, garanti süresi 2 yıldır.

Thailand only

This telecommunication equipment conforms to NTC technical requirement.

China only

回收和再循环

为了保护环境，我们公司已经为废弃的产品建立了回收和再循环系统。我们会为您无偿提供回收同类废旧产品的服务。当您废弃您正在使用的产品时，请您及时与授权耗材更换中心取得联系，我们会及时为您提供服务。

Regulatory information

Website: <http://www.samsung.com/cn/support/location/supportServiceLocation.do?page=SERVICE.LOCATION>

中国能效标识

型号	能效等级	典型能耗 (kWh)
Xpress C430	1	1.02
Xpress C430W	1	1.02

依据国家标准 GB 21521-2014

产品中有害物质的名称及含量

部件名称	有害物质					
	铅 (Pb)	汞 (Hg)	镉 (Cd)	六价铬 (Cr ⁶⁺)	多溴联苯 (PBB)	多溴二苯醚 (PBDE)
塑料	○	○	○	○	○	○
金属 (机箱)	×	○	○	○	○	○
印刷电路部件 (PCA)	×	○	○	○	○	○
电缆 / 连接器	×	○	○	○	○	○
电源设备	×	○	○	○	○	○
电源线	×	○	○	○	○	○
机械部件	×	○	○	○	○	○
卡盒部件	×	○	○	○	○	○
定影部件	×	○	○	○	○	○
扫描仪部件 - CCD (如果有)	×	×	○	○	○	○
扫描仪部件 - 其它 (如果有)	×	○	○	○	○	○
印刷电路板部件 (PBA)	×	○	○	○	○	○
墨粉	○	○	○	○	○	○
滚筒	○	○	○	○	○	○

本表格依据 SJ/T 11364 的规定编制。

○：表示该有害物质在该部件所有均质材料中的含量均在 GB/T 26572 规定的限量要求以下。

×：表示该有害物质至少在该部件的某一均质材料中的含量超出 GB/T 26572 规定的限量要求。

Copyright

© 2015 Samsung Electronics Co., Ltd. All rights reserved.

This user's guide is provided for information purposes only. All information included herein is subject to change without notice.

Samsung Electronics is not responsible for any direct or indirect damages, arising from or related to use of this user's guide.

- Samsung and the Samsung logo are trademarks of Samsung Electronics Co., Ltd.
- Microsoft, Windows XP Service Pack 3, Windows Vista, Windows 7, Windows 8, Windows Server 2008 R2, Windows 10 and Windows Server 2016 are either registered trademarks or trademarks of Microsoft Corporation.
- Microsoft, Internet Explorer, Excel, Word, PowerPoint, and Outlook are either registered trademarks or trademarks of Microsoft Corporation in the United States and other countries.
- Google, Picasa, Google Cloud Print, Google Docs, Android and Gmail are either registered trademarks or trademarks of Google Inc.
- iPad, iPhone, iPod touch, Mac and Mac OS are trademarks of Apple Inc., registered in the U.S and other countries.
- AirPrint and the AirPrint logo are trademarks of Apple Inc.
- All other brand or product names are trademarks of their respective companies or organizations.



QR code

The software included in this product contains open source software. You may obtain the complete corresponding source code for a period of three years after the last shipment of this product by sending an email to <mailto:oss.request@samsung.com>. It is also possible to obtain the complete corresponding source code in a physical medium such as a CD-ROM; a minimal charge will be required.

The following URL https://opensource.samsung.com/opensource/Samsung_C43x_Series/seq/49 leads to the download page of the source code made available and open source license information as related to this product. This offer is valid to anyone in receipt of this information.

User's Guide

Samsung Printer *Xpress*

C43x series

C43xW series

ADVANCED

This guide provides information about installation, advanced configuration, operation and troubleshooting on various OS environments.

Some features may not be available depending on models or countries.

BASIC

This guide provides information concerning installation, basic operation and troubleshooting on windows.



1. Software Installation

Installation for Mac	93
Reinstallation for Mac	94
Installation for Linux	95
Reinstallation for Linux	96



2. Using a Network-Connected Machine

Useful network programs	98
Wired network setup	99
Installing driver over the network	102
IPv6 configuration	107
Wireless network setup	109
Samsung Mobile Print	126
Using the NFC feature	127
Mopria™	130
AirPrint	132
Samsung Cloud Print	134
Google Cloud Print™	136



3. Special Features

Altitude adjustment	140
Printing features	141



4. Useful Management Tools

Accessing management tools	154
Easy Capture Manager	155
Samsung Easy Color Manager	156
Easy Eco Driver	157
Using Samsung Printer Center	158
Using SyncThru™ Web Service	161
Using Samsung Easy Printer Manager	164
Using Samsung Printer Status	166
Using Samsung Printer Experience	168



5. Troubleshooting

Paper feeding problems	175
Power and cable connecting problems	176
Printing problems	177
Printing quality problems	181
Operating system problems	189



1. Software Installation

This chapter provides instructions for installing essential and helpful software for use in an environment where the machine is connected via a cable. A locally connected machine is a machine directly attached to your computer using a USB cable. If your machine is attached to a network, skip the following steps below and go on to installing a network connected machine's driver (see [Installing driver over the network](#)¹⁰²).

- **Installation for Mac** **93**
- **Reinstallation for Mac** **94**
- **Installation for Linux** **95**
- **Reinstallation for Linux** **96**



- If you are a Windows OS user, refer to the "Installing the driver locally" on page 23 for installing the machine's driver.
- Only use a USB cable no longer than 3 meter (118 inches).

Installation for Mac

- 1 Make sure that the machine is connected to your computer and powered on.
- 2 Insert the supplied software CD into your CD-ROM drive.
- 3 Select the CD-ROM volume that appears on **Finder**.
- 4 Double-click the **Install Software** icon.
- 5 Read the license agreement and check installation agreement button.
- 6 Click **Next** and then follow the instructions in the installation window.



To install the fax driver:

- a Open the **Applications** folder > **Samsung** > **Fax Queue Creator**.
- b Your machine appears on the **Printer List**
- c Select machine to use and click **Create** button

Reinstallation for Mac

If the printer driver does not work properly, uninstall the driver and reinstall it.

- 1 Open the **Applications** folder > **Samsung** > **Printer Software Uninstaller**.
- 2 To uninstall printer software, click **Continue**.
- 3 Check the program you want to delete and click **Uninstall**.
- 4 Enter the password and click **OK**.
- 5 After the uninstallation is finished, click **Close**.



If a machine has already been added, delete it from the **Print Setup Utility** or **Print & Fax**.

Installation for Linux

You need to download Linux software packages from the Samsung website to install the printer software (<http://www.samsung.com> > find your product > Support or Downloads).

Installing the Unified Linux Driver



You must log in as a super user (root) to install the machine software. If you are not a super user, ask your system administrator.

- 1 Make sure that the machine is connected to your computer and powered on.
- 2 Copy **Unified Linux Driver** package to your system.
- 3 Open Terminal program and go to the folder that you copied the package to.
- 4 Extract the package.
- 5 Move to **uld** folder.
- 6 Execute **./install.sh** command (If you're not logged in as root, execute the command with **sudo** as **sudo ./install.sh**)
- 7 Proceed with installation.

- 8 When installation finished, launch printing utility(Go to **System** > **Administration** > **Printing** or execute **"system-config-printer"** command in Terminal program).
- 9 Click **Add** button.
- 10 Select your printer.
- 11 Click **Forward** button and add it to your system.

Reinstallation for Linux

If the printer driver does not work properly, uninstall the driver and reinstall it.

- 1 Open **Terminal** program.
- 2 Move to **uld** folder extracted from **Unified Linux Driver** package.
- 3 Execute "**./uninstall.sh**" command (If you're not logged in as root, execute the command with "**sudo**" as "**sudo ./uninstall.sh**")
- 4 Proceed with uninstallation.



2. Using a Network-Connected Machine

This chapter gives you step-by-step instructions for setting up a network connected machine and software.

- **Useful network programs** 98
- **Wired network setup** 99
- **Installing driver over the network** 102
- **IPv6 configuration** 107
- **Wireless network setup** 109
- **Samsung Mobile Print** 126
- **Using the NFC feature** 127
- **Mopria™** 130
- **AirPrint** 132
- **Samsung Cloud Print** 134
- **Google Cloud Print™** 136



Supported optional devices and features may differ according to your model (see "Features by model" on page 6).

Useful network programs

There are several programs available to setup the network settings easily in a network environment. For the network administrator especially, managing several machines on the network is possible.



- Before using the programs below, set the IP address first.
- Some features and optional goods may not be available depending on model or country (see "Features by model" on page 6).

SyncThru™ Web Service

The web server embedded on your network machine allows you to do the following tasks (see "Using SyncThru™ Web Service" on page 161).

- Check the supplies information and status.
- Customize machine settings.
- Set the email notification option. When you set this option, the machine status (toner cartridge shortage or machine error) will be sent to a certain person's email automatically.
- Configure the network parameters necessary for the machine to connect to various network environments.

SetIP wired network setup

This utility program allows you to select a network interface and manually configure the IP addresses for use with the TCP/IP protocol.

- See "IPv4 configuration using SetIP (Windows)" on page 99.
- See "IPv4 configuration using SetIP (Mac)" on page 100.
- See "IPv4 configuration using SetIP (Linux)" on page 100.



- If your device does not support a network connection, it will not be able to use this feature (see "Rear view" on page 19).
- TCP/IPv6 is not supported by this program.

Wired network setup

Printing a network configuration report

You can print **Network Configuration Report** from the machine's control panel that will show the current machine's network settings. This will help you to set up a network.

Press the  (**Cancel** or **Stop/Clear**) button for two seconds on the control panel.

Using this **Network Configuration Report**, you can find your machine's MAC address and IP address.

For example:

- MAC Address: 00:15:99:41:A2:78
- IP Address: 169.254.192.192

Setting IP address



- If your device does not support a network connection, it will not be able to use this feature (see "Rear view" on page 19).
- TCP/IPv6 is not supported by this program.

First, you have to set up an IP address for network printing and managements. In most cases a new IP address will be automatically assigned by a DHCP (Dynamic Host Configuration Protocol) server located on the network.

IPv4 configuration using SetIP (Windows)

Before using the SetIP program, disable the computer firewall from **Control Panel > Security Center > Windows Firewall**.



The following instructions may differ for your model.

- 1 Download the software from the Samsung website then unpack and install it: (<http://www.samsung.com> > find your product > Support or Downloads).
- 2 Follow the instructions in the installation window.
- 3 Connect your machine to the network with a network cable.
- 4 Turn on the machine.
- 5 From the Windows **Start** menu, select **All Programs > Samsung Printers > SetIP > SetIP**.
- 6 Click the  icon (third from left) in the SetIP window to open the TCP/IP configuration window.

Wired network setup

- 7 Enter the machine's new information into the configuration window. In a corporate intranet, you may need to have this information assigned by a network manager before proceeding.



Find the machine's MAC address from the **Network Configuration Report** (see "Printing a network configuration report" on page 99) and enter it without the colons. For example, 00:15:99:29:51:A8 becomes 0015992951A8.

- 8 Click **Apply**, and then click **OK**. The machine will automatically print the **Network Configuration Report**. Confirm that all the settings are correct.

IPv4 configuration using SetIP (Mac)

Before using the SetIP program, disable the computer firewall from **System Preferences > Security** (or **Security & Privacy**) > **Firewall**.

- 1 Download the software from the Samsung website then unpack and install it: (<http://www.samsung.com> > find your product > Support or Downloads).
- 2 Turn on the machine.
- 3 Run downloaded **SetIP** application

- 4 Click the  icon (third from left) in the SetIP window to open the TCP/IP configuration window.

- 5 Enter the machine's new information into the configuration window. In a corporate intranet, you may need to have this information assigned by a network manager before proceeding.



Find the machine's MAC address from the **Network Configuration Report** (see "Printing a network configuration report" on page 99) and enter it without the colons. For example, 00:15:99:29:51:A8 becomes 0015992951A8.

- 6 Click **Apply**, and then click **OK**. The machine will automatically print the **Network Configuration Report**. Confirm that all the settings are correct.

IPv4 configuration using SetIP (Linux)

Before using the SetIP program, disable the computer firewall from **System Preferences** or **Administrator**.



The following instructions may vary from your model or operating systems.

Wired network setup

- 1 Download SetIP program from Samsung web site and extract it.
- 2 Double-click the **SetIPApplet.html** file in **cdroot/Linux/noarch/at_opt/share/utils** folder.
- 3 Click to open the TCP/IP configuration window.
- 4 Enter the machine's new information into the configuration window. In a corporate intranet, you may need to have this information assigned by a network manager before proceeding.



Find the machine's MAC address from the **Network Configuration Report** (see "Printing a network configuration report" on page 99) and enter it without the colons. For example, 00:15:99:29:51:A8 becomes 0015992951A8.

- 5 The machine will automatically print the **Network Configuration Report**.

Installing driver over the network



- Some features and optional goods may not be available depending on model or country (see "Features by model" on page 6).
- The machine that does not support the network interface, it will not be able to use this feature (see "Rear view" on page 19).
- You can install the printer driver and software when you insert the software CD into your CD-ROM drive.
For windows, select the printer driver and software in the **Select Software to Install** window.

Windows



- The firewall software might be blocking network communication. Before connecting the device to the network, disable the computer's firewall.

- 1 Make sure that the machine is connected to the network and powered on. Also, your machine's IP address should have been set (see "Setting IP address" on page 99).
- 2 Insert the supplied software CD into your CD-ROM drive.
If the installation window does not appear, click **Start > All programs > Accessories > Run**.
X:\Setup.exe replacing "X" with the letter, which represents your CD-ROM drive and click **OK**.
 - For Windows 8,
If the installation window does not appear, from **Charms**, select **Search > Apps** and search for **Run**. Type in X:\Setup.exe, replacing "X" with the letter that represents your CD-ROM drive and click **OK**.
If "**Tap to choose what happens with this disc.**" pop-up window appears, click the window and select **Run Setup.exe**.
- 3 Review and accept the installation agreements in the installation window. Then, click **Next**.
- 4 Select **Network** on the **Printer Connection Type** screen Then, click **Next**.
- 5 Follow the instructions in the installation window.

Installing driver over the network

From the Windows 8 Start Screen



- The V4 driver is automatically downloaded from the Windows Update if your computer is connected to the Internet. If not, you can manually download the V4 driver from Samsung website, <http://www.samsung.com> > find your product > Support or downloads.
- You can download **Samsung Printer Experience** app from the **Windows Store**. You need have a Microsoft account to use the Windows Store.
 - a From **Charms**, select **Search**.
 - b Click **Store**.
 - c Search and click **Samsung Printer Experience**.
 - d Click **Install**.
- If you install the driver using the supplied software CD, V4 driver is not installed. If you want to use the V4 driver in the **Desktop** screen, you can download from the Samsung website, <http://www.samsung.com> > find your product > Support or downloads.
- If you want to install Samsung's printer management tools, you need to install them using the supplied software CD.

- 1 Make sure that the machine is connected to the network and powered on. Also, your machine's IP address should have been set (see "Setting IP address" on page 99).
- 2 From **Charms**, select **Settings** > **Change PC settings** > **Devices**.
- 3 Click **Add a device**.
Discovered machines will be shown on the screen.

- 4 Click the model name or host name you wish to use.



You can print a Network Configuration Report from the machine's control panel that will show the current machine's host name (see "Printing a network configuration report" on page 119).

- 5 The driver is automatically installed from the **Windows Update**.

Silent installation Mode

Silent installation mode is an installation method that does not require any user intervention. Once you start the installation, the machine driver and software are automatically installed on you computer. You can start the silent installation by typing **/s** or **/S** in the command window.



Command-line Parameters

Following table shows commands that can be used in the command window.



Following command-line are effective and operated when command is used with **/s** or **/S**. But **/h**, **/H** or **/?** are exceptional commands that can be operated solely.

Installing driver over the network

Command- line	Definition	Description
/s or /S	Starts silent installation.	Installs machine drivers without prompting any UIs or user intervention.
/p"<port name>" or /P"<port name>"	<p>Specifies printer port.</p>  <p>Network Port will be created by use of Standard TCP/IP Port monitor. For local port, this port must exist on system before being specified by command.</p>	<p>Printer port name can be specified as IP address, hostname, USB local port name or IEEE1284 port name.</p> <p>For example:</p> <ul style="list-style-type: none"> /p"xxx.xxx.xxx.xxx" in where, "xxx.xxx.xxx.xxx" means IP address for network printer. /p"USB001", /P"LPT1:", /p"hostname"
/a"<dest_path>" or /A"<dest_path>"	<p>Specifies destination path for installation.</p>  <p>The destination path should be a fully qualified path.</p>	<p>Since machine drivers should be installed on the OS specific location, this command applies to only application software.</p>

Command- line	Definition	Description
/n"<Printer name>" or /N"<Printer name>"	Specifies printer name. Printer instance shall be created as specified printer name.	With this parameter, you can add printer instances as you wish.
/nd or /ND	Commands not to set the installed driver as a default machine driver.	It indicates installed machine driver will not be the default machine driver on your system if there are one or more printer drivers installed. If there is no installed machine driver on your system, then this option won't be applied because Windows OS will set installed printer driver as a default machine driver.
/x or /X	Uses existing machine driver files to create printer instance if it is already installed.	This command provides a way to install a printer instance that uses installed printer driver files without installing an additional driver.

Installing driver over the network

Command- line	Definition	Description
/up"<printer name>" or /UP"<printer name>"	Removes only specified printer instance and not the driver files.	This command provides a way to remove only specified printer instance from your system without effecting other printer drivers. It will not remove printer driver files from your system.
/d or /D	Uninstalls all device drivers and applications from your system.	This command will remove all installed device drivers and application software from your system.
/v"<share name>" or /V"<share name>"	Shares installed machine and add other available platform drivers for Point & Print.	It will install all supported Windows OS platform's machine drivers to system and share it with specified <share name> for point and print.
/o or /O	Opens Printers and Faxes folder after installation.	This command will open Printers and Faxes folder after the silent installation.
/h, /H or /?	Shows Command-line Usage.	

Mac

- 1 Make sure that the machine is connected to your computer and powered on.
- 2 Insert the supplied software CD into your CD-ROM drive.
- 3 Select the CD-ROM volume that appears on **Finder**.
- 4 Double-click the **Install Software** icon.
- 5 Read the license agreement and check installation agreement button.
- 6 Click **Next**.
- 7 Select **Network** on the printer connection type screen.
- 8 Click **Next**.
- 9 Follow the instructions in the installation window.

Installing driver over the network

Linux

You need to download Linux software packages from the Samsung website to install the printer software (<http://www.samsung.com> > find your product > Support or Downloads).

- 1 Make sure that the machine is connected to your network and powered on. Also, your machine's IP address should have been set.
- 2 Copy **Unified Linux Driver** package to your system.
- 3 Open Terminal program and go to the folder that you copied the package to.
- 4 Extract the package.
- 5 Move to **uld** folder.
- 6 Execute "**./install.sh**" command (If you are not logged in as root, execute the command with "**sudo**" as "**sudo ./install.sh**").
- 7 Proceed with installation.
- 8 When installation finished, launch **Printing** utility (Go to **System** > **Administration** > **Printing** or execute "**system-config-printer**" command in Terminal program).

- 9 Click **Add** button.
- 10 Select **AppSocket/HP JetDirect** and enter your machine's IP address.
- 11 Click **Forward** button and add it to your system.

IPv6 configuration



IPv6 is supported properly only in Windows Vista or higher.



If the IPv6 network seems to not be working, set all the network setting to the factory defaults and try again using **Clear Setting**.

The machine supports the following IPv6 addresses for network printing and managements.

- **Link-local Address:** Self-configured local IPv6 address (Address starts with FE80).
- **Stateless Address:** Automatically configured IPv6 address by a network router.
- **Stateful Address:** IPv6 address configured by a DHCPv6 server.
- **Manual Address:** Manually configured IPv6 address by a user.

In the IPv6 network environment, follow the next procedure to use the IPv6 address.

From the SyncThru™ Web Service

Activating IPv6

- 1 Access a web browser, such as Internet Explorer, from Windows. Enter the machine IP address (http://xxx.xxx.xxx.xxx) in the address field and press the Enter key or click **Go**.
- 2 If it's your first time logging into **SyncThru™ Web Service** you need to log-in as an administrator. Type in the below default ID and password. We recommend you to change the default password for security reasons.
 - **ID: admin**
 - **Password: sec00000**
- 3 When the **SyncThru™ Web Service** window opens, move the mouse cursor over the **Settings** of the top menu bar and then click **Network Settings**.
- 4 Click **TCP/IPv6** on the left pane of the website.
- 5 Check the **IPv6 Protocol** check box to activate IPv6.
- 6 Click the **Apply** button.
- 7 Turn the machine off and turn it on again.

IPv6 configuration



- You can also set the DHCPv6.
- To manually set the IPv6 address:
Check the **Manual Address** check box. Then, the **Address/Prefix** text box is activated. Enter the rest of the address (e.g.,:3FFE:10:88:194::**AAAA**. "A" is the hexadecimal 0 through 9, A through F).



Address must be enclosed in '[']' brackets.

IPv6 address configuration

- 1 Start a web browser, such as Internet Explorer, that supports IPv6 addressing as a URL.
- 2 Select one of the IPv6 addresses (**Link-local Address, Stateless Address, Stateful Address, Manual Address**) from **Network Configuration Report** (see "Printing a network configuration report" on page 99).
 - **Link-local Address:** Self-configured local IPv6 address (Address starts with FE80).
 - **Stateless Address:** Automatically configured IPv6 address by a network router.
 - **Stateful Address:** IPv6 address configured by a DHCPv6 server.
 - **Manual Address:** Manually configured IPv6 address by a user.
- 3 Enter the IPv6 addresses (e.g.,: http://[FE80::215:99FF:FE66:7701]).

Wireless network setup



- Wireless networking may not be available depending on the model (see "Features by model" on page 6).

Wireless networks require higher security, so when an access point is first set up, a network name (SSID), the type of security used, and a Network Password are created for the network. Ask your network administrator about this information before proceeding with the machine installation.

Introducing wireless set up methods

You can set wireless settings either from the machine or the computer. Choose the setting method from the below table.



- Some wireless network installation types may not be available depending on the model or country.
- It is strongly recommended that you set the password on Access Points. If you do not set the password on Access Points, they might be exposed to illegal access from unknown machines including PCs, smart phones and printers. Refer to the Access Point user' guide for password settings.

Set up method	Connecting method	Description & Reference
With Access Point	From the computer	See "Setting up via USB cable" on page 113 for Window.
		See "Access point without a USB cable" on page 115 for Window.
		See "Setting up via USB cable" on page 117 for Mac.
		See "Access point without a USB cable" on page 118 for Mac.
	From the machine's control panel	See "Using a network cable" on page 119.
From the machine's control panel	See "Using the WPS button" on page 110.	
Wi-Fi Direct setup		See "Setting the Wi-Fi Direct for mobile printing" on page 121.

Wireless network setup

Using the WPS button

If your machine and access point (or wireless router) support Wi-Fi Protected Setup™ (WPS), then you can easily configure the wireless network settings through the **WPS** button menu without the need for a computer.



- If you want to use the wireless network using the infrastructure mode, make sure that the network cable is disconnected from the machine. Using the **WPS (PBC)** button or entering the PIN from the computer to connect to the access point (or wireless router) varies depending on the access point (or wireless router) you are using. Refer to the user's guide of the access point (or wireless router) you are using.
- When using the WPS button to set the wireless network, security settings may change. To prevent this, lock the WPS option for the current wireless security settings. The option name may differ depending on the access point (or wireless router) you are using.

Items to prepare

- Check if the access point (or wireless router) supports Wi-Fi Protected Setup™ (WPS).
- Check if your machine supports Wi-Fi Protected Setup™ (WPS).
- Networked computer (PIN mode only)

Choosing your type

There are two methods available to connect your machine to a wireless network.

- The **Push Button Configuration (PBC)** method allows you to connect your machine to a wireless network by pressing both the **WPS** button menu on the control panel of your machine and the WPS (PBC) button on a Wi-Fi Protected Setup™ WPS-enabled access point (or wireless router) respectively.
- The **Personal Identification Number (PIN)** method helps you connect your machine to a wireless network by entering the supplied PIN information on a Wi-Fi Protected Setup™ WPS-enabled access point (or wireless router).

Wireless network setup

Connecting WPS

Factory default in your machine is **PBC** mode, which is recommended for a typical wireless network environment.

Connecting in PBC mode

- 1 Press and hold the  (WPS) button on the control panel for about 2 - 4 seconds until the status LED blinks quickly.

The machine starts connecting to the wireless network. The LED blinks slowly for up to two minutes until you press the PBC button on the access point (or wireless router).

- 2 Press the **WPS (PBC)** button on the access point (or wireless router).
 - a The light blinks fast on the WPS LED. The machine is connecting to the access point (or wireless router).
 - b When the machine is successfully connected to the wireless network, the WPS LED light stays on.
- 3 Insert the supplied software CD into your CD-ROM drive, and follow the instructions in the window to set up the wireless network.

Connecting in PIN mode

- 1 The network configuration report, including PIN, must be printed (see "Printing a network configuration report" on page 99).

In ready mode, press and hold the  (**Cancel** or **Stop/Clear**) button on the control panel for about 5 seconds. You can find your machine's PIN.

- 2 Press and hold the  (WPS) button on the control panel for more than 4 seconds until the status LED stays on.

The machine starts connecting to the access point (or wireless router).

- 3 You need to enter the eight-digit PIN within two minutes on the computer that is connected to the access point (or wireless router).

The LED blinks slowly for up to two minutes until you enter the eight-digit PIN.

The WPS LED blinks in the order below:

- a The light blinks fast on the WPS LED. The machine is connecting to the access point (or wireless router).
 - b When the machine is successfully connected to the wireless network, the WPS LED light stays on.
- 4 Insert the supplied software CD into your CD-ROM drive, and follow the instructions in the window to set up the wireless network.

Wireless network setup

Re-connecting to a network

When the wireless function is off, the machine automatically tries to re-connect to the access point (or wireless router) with the previously used wireless connection settings and address.



In the following cases, the machine automatically re-connects to the wireless network:

- The machine is turned off and on again.
- The access point (or wireless router) is turned off and on again.

Canceling the connection process

To cancel the wireless network connection when the machine is connecting to the wireless network, press and release the  (**Cancel** or **Stop/Clear**) on the control panel. **You need to wait 2 minutes to re-connect to the wireless network.**

Disconnecting from a network

To disconnect the wireless network connection, press the  (WPS) button on the control panel for more than two seconds.

- **When the Wi-Fi network is in idle mode:** The machine is immediately disconnected from the wireless network and the WPS LED turns off.
- **When the Wi-Fi network is being used:** While the machine waits until the current job is finished, the light blinks fast on the WPS LED. Then, the wireless network connection is automatically disconnected and the WPS LED turns off.

Setup using Windows



Shortcut to the **Samsung Easy Wireless Setup** program without the CD: If you have installed the printer driver once, you can access the **Samsung Easy Wireless Setup** program without the CD.

Wireless network setup

Setting up via USB cable

Items to prepare

- Access point
- Network-connected computer
- Software CD that was provided with your machine
- A machine installed with a wireless network interface
- USB cable

Creating the infrastructure network

- 1 Check whether the USB cable is connected to the machine.
- 2 Turn on your computer, access point, and machine.

- 3 Insert the supplied software CD into your CD-ROM drive.

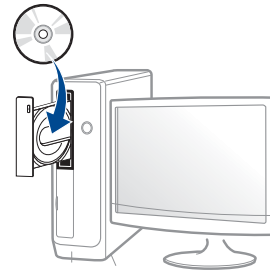

If the installation window does not appear, click **Start > All programs > Accessories > Run**.

X:\Setup.exe replacing "X" with the letter, which represents your CD-ROM drive and click **OK**.

- For Windows 8,
If the installation window does not appear, from **Charms**, select **Search > Apps** and search for **Run**. Type in X:\Setup.exe, replacing "X" with the letter that represents your CD-ROM drive and click **OK**.
If "**Tap to choose what happens with this disc.**" pop-up window appears, click the window and select **Run Setup.exe**.

- 4 Review and accept the installation agreements in the installation window. Then, click **Next**.
- 5 Select **Wireless** on the **Printer Connection Type** screen. Then, click **Next**.

Wireless network setup

- 6 On the **Are you setting up your printer for the first time?** screen, select **Yes, I will set up my printer's wireless network.** Then, click **Next.**

If your printer is already connected on the network, select **No, my printer is already connected to my network.**

- 7 Select **Using a USB cable** on the **Select the Wireless Setup Method** screen. Then, click **Next.**

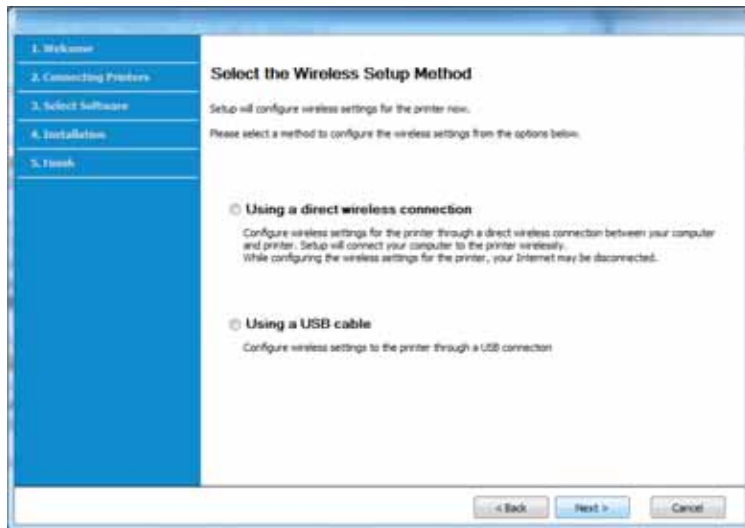

- 8 After searching, the window shows the wireless network devices. Select the name (SSID) of the access point you want to use and click **Next.**



If you cannot find the network name you want to choose, or if you want to set the wireless configuration manually, click **Advanced Setting.**

- **Enter the wireless Network Name:** Enter the SSID of the access point (SSID is case-sensitive).
- **Operation Mode:** Select **Infrastructure.**
- **Authentication:** Select an authentication type.
 - Open System:** Authentication is not used, and encryption may or may not be used, depending on the need for data security.
 - Shared Key:** Authentication is used. A device that has a proper WEP key can access the network.
 - WPA Personal or WPA2 Personal:** Select this option to authenticate the print server based on a WPA Pre-Shared Key. This uses a shared secret key (generally called Pre Shared Key pass phrase), which is manually configured on the access point and each of its clients.
- **Encryption:** Select the encryption (None, WEP64, WEP128, TKIP, AES, TKIP AES).
- **Network Password:** Enter the encryption network password value.
- **Confirm Network Password:** Confirm the encryption network password value.
- **WEP Key Index:** If you are using WEP Encryption, select the appropriate **WEP Key Index.**



The wireless network security window appears when the access point has security settings.

Enter the Network Password of the access point (or router).

Wireless network setup

- 9 If your printer supports Wi-Fi Direct, the following screen appears. Click **Next**.



- Wi-Fi Direct option appears on the screen only if your printer supports this feature.
- Can start to build Wi-Fi Direct by using Samsung Easy Printer Manager (see "Setting up Wi-Fi Direct" on page 121).
- **Wi-Fi Direct Name:** The default Wi-Fi Direct Name is the model name and the maximum length is 22 characters.
- **Password setting** is the numeric string, and the size is 8 ~ 64 characters.

- 10 When the wireless network set up is completed, disconnect the USB cable between the computer and machine. Click **Next**.

- 11 Select the components to be installed.
- 12 Follow the instructions in the installation window.

Access point without a USB cable

Items to prepare

- WiFi-enabled PC running Windows 7 or higher and an access point (router)
- Software CD that was provided with your machine
- A machine installed with a wireless network interface



While setting the wireless network, the machine uses PC's wireless LAN. You might not be able to connect to the Internet.

Wireless network setup

Creating the infrastructure network

- 1 Turn on your computer, access point, and machine.
- 2 Insert the supplied software CD into your CD-ROM drive.

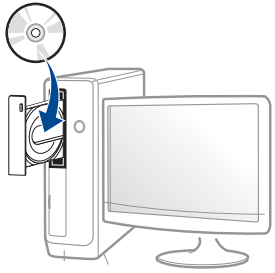

If the installation window does not appear, click **Start > All programs > Accessories > Run**.

X:\Setup.exe replacing "X" with the letter, which represents your CD-ROM drive and click **OK**.

- For Windows 8,
If the installation window does not appear, from **Charms**, select **Search > Apps** and search for **Run**. Type in X:\Setup.exe, replacing "X" with the letter that represents your CD-ROM drive and click **OK**.
If "**Tap to choose what happens with this disc.**" pop-up window appears, click the window and select **Run Setup.exe**.

- 3 Review and accept the installation agreements in the installation window. Then, click **Next**.
- 4 Select **Wireless** on the **Printer Connection Type** screen. Then, click **Next**.

- 5 On the **Are you setting up your printer for the first time?** screen, select **Yes, I will set up my printer's wireless network**. Then, click **Next**.

If your printer is already connected on the network, select **No, my printer is already connected to my network**.

- 6 Select **Using a direct wireless connection** on the **Select the Wireless Setup Method** screen. Then, click **Next**.

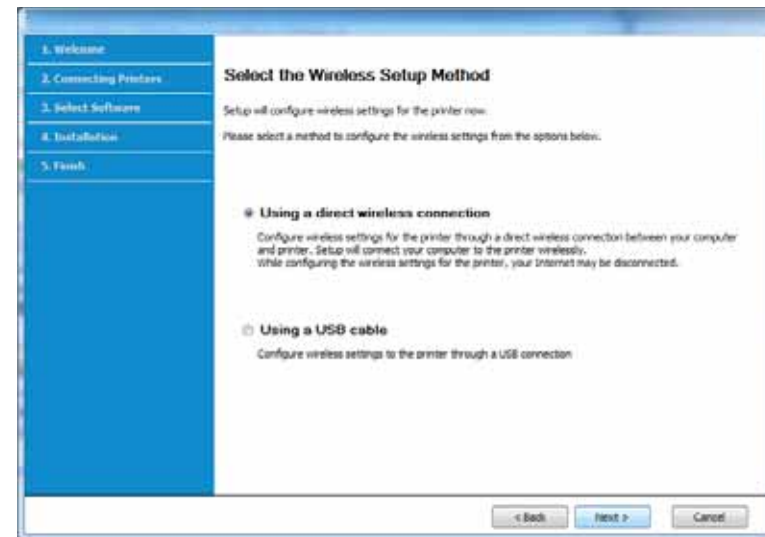

- Even if your computer is running Windows 7 or higher, you cannot use this feature if your PC does not support wireless network. Set the wireless network using a USB cable (see "Setting up via USB cable" on page 113).
- If below screen appears, press the  (WPS) button from the control panel within 2 minutes.

Wireless network setup

- 7 When the wireless network set up is completed, click **Next**.
- 8 Follow the instructions in the installation window.

Setup using Mac

Items to prepare

- Access point
- Network-connected computer
- Software CD that was provided with your machine
- A machine installed with a wireless network interface
- USB cable

Setting up via USB cable

- 1 Make sure that the machine is connected to your computer and powered on.
- 2 Insert the supplied software CD into your CD-ROM drive.
- 3 Select the CD-ROM volume that appears on **Finder**.
- 4 Double-click **Install Software** icon.

- 5 Read the license agreement and check installation agreement button.
- 6 Click **Next**
- 7 Select **Wireless** on the **Printer Connection Type**
- 8 Click **Next**
- 9 If the installer asks you to allow access to the keychain, click **Deny**.



If you clicked **Always Allow** in this step, the **Select a wireless printer** window appears without asking for access to the keychain. If this occurs, click **Cancel** in the **Select a wireless printer** window.

- 10 On the **Select the Wireless Setup Method** screen, select **Using a USB cable**, and then click **Next**.
If the screen does not appear, go to step 14.
- 11 After searching, the window shows the wireless network devices. Select the name (SSID) of the access point you want to use and click **Next**.



When you set the wireless configuration manually, click **Advanced Setting**.

- **Enter the wireless Network Name:** Enter the SSID of the access point (SSID is case-sensitive).
- **Operation Mode:** Select **Infrastructure**.

Wireless network setup

- **Authentication:** Select an authentication type.
Open System: Authentication is not used, and encryption may or may not be used, depending on the need for data security.
Shared Key: Authentication is used. A device that has a proper WEP key can access the network.
WPA Personal or WPA2 Personal: Select this option to authenticate the print server based on the WPA Pre-Shared Key. This uses a shared secret key (generally called Pre Shared Key pass phrase) that is manually configured on the access point and each of its clients.
- **Encryption:** Select the encryption. (None, WEP64, WEP128, TKIP, AES)
- **Network Key:** Enter the encryption network key value.
- **Confirm Network Key:** Confirm the encryption network key value.
- **WEP Key Index:** If you are using WEP Encryption, select the appropriate **WEP Key Index**.

The wireless network security window appears when the access point has security enabled.

Enter the Network Key of the access point (or router).

- 12** The window showing the wireless network setting appears. Check the settings and click **Next**.



- Can start to build Wi-Fi Direct by using Samsung Easy Printer Manager (see "Setting up Wi-Fi Direct" on page 121).
- **Wi-Fi Direct Name:** The default Wi-Fi Direct Name is the model name and the maximum length is 22 characters.
- **Password setting** is the numeric string, and the size is 8 ~ 64 characters.

- 13** The **Wireless Network Setting Complete** window appears. Click **Next**.
- 14** When the wireless network settings are completed, disconnect the USB cable between the computer and machine. Click **Next**.
- 15** Follow the instructions in the installation window.

Access point without a USB cable

Items to prepare

- WiFi-enabled Mac running Mac OS 10.7 or higher and an access point (router)
- Software CD that was provided with your machine
- A machine installed with a wireless network interface

- 1** Make sure that the machine is connected to your computer and powered on.
- 2** Insert the supplied software CD into your CD-ROM drive.
- 3** Select the CD-ROM volume that appears on **Finder**.
- 4** Double-click **Install Software** icon.
- 5** Read the license agreement and check installation agreement button.
- 6** Click **Next**.

Wireless network setup

- 7 Select **Wireless** on the **Printer Connection Type** screen.
- 8 Click **Next**.
- 9 If the installer asks you to allow access to the keychain, click **Allow**.
- 10 If the **Select a wireless printer** window appears, select the printer named DIRECT-xxx.



If the **Press WPS button on your printer** screen appears, press the  (WPS) button from the control panel within 2 minutes.

- 11 When the wireless network set up is complete, follow the instructions in the installation window.

Using a network cable



See your network administrator, or the person that set up your wireless network, for information about your network configuration.

Your machine is a network compatible machine. To enable your machine to work with your network, you will need to perform some configuration procedures.

Items to prepare

- Access point
- Network-connected computer
- Software CD that was provided with your machine
- A machine installed with a wireless network interface
- Network cable

Printing a network configuration report

You can identify the network settings of your machine by printing a network configuration report.

See "Printing a network configuration report" on page 99.

IP setting using SetIP Program (Windows)

This program is used to manually set the network IP address of your machine using its MAC address to communicate with the machine. The MAC address is the hardware serial number of the network interface and can be found in the **Network Configuration Report**.

See "Printing a network configuration report" on page 99.

Wireless network setup

Configuring the machine's wireless network

Before starting you will need to know the network name (SSID) of your wireless network and the network key if it is encrypted. This information was set when the access point (or wireless router) was installed. If you do not know about your wireless environment, please ask the person who set up your network.

To configure wireless parameters, you can use **SyncThru™ Web Service**.

Using SyncThru™ Web Service

Before starting wireless parameter configuration, check the cable connection status.

- 1 Check whether or not the network cable is connected to the machine. If not, connect the machine with a standard network cable.
- 2 Start a web browser such as Internet Explorer, Safari, or Firefox and enter your machine's new IP address in the browser window.

For example,



http://192.168.1.133/

- 3 Click **Login** on the upper right of the SyncThru™ Web Service website.

- 4 If it's your first time logging into **SyncThru™ Web Service** you need to log-in as an administrator. Type in the below default ID and password. We recommend you to change the default password for security reasons.

- **ID: admin**
- **Password: sec0000**

- 5 When the **SyncThru™ Web Service** window opens, click **Network Settings**.

- 6 Click **Wi-Fi > Wizard**.

- 7 Select the one **Network Name(SSID)** in the list.

- 8 Click **Next**.

If the wireless security setting window appears, enter the registered password (network password) and click **Next**.

- 9 The confirmation window appears, please check your wireless setup. If the setup is right, click **Apply**.

Wireless network setup

Turning the Wi-Fi network on/off

- 1 Check whether the network cable is connected to the machine. If not, connect the machine with a standard network cable.
- 2 Start a web browser such as Internet Explorer, Safari, or Firefox and enter your machine's new IP address in the browser window.

For example,



- 3 Click **Login** on the upper right of the SyncThru™ Web Service website.
- 4 If it's your first time logging into **SyncThru™ Web Service** you need to log-in as an administrator. Type in the below default ID and password. We recommend you to change the default password for security reasons.
 - **ID: admin**
 - **Password: sec00000**
- 5 When the **SyncThru™ Web Service** window opens, click **Network Settings**.
- 6 Click **Wi-Fi**.
- 7 You can turn the Wi-Fi network on/off.

Setting the Wi-Fi Direct for mobile printing

Wi-Fi Direct is a secure and easy-to-use peer-to-peer connection between a Wi-Fi Direct-enabled printer and mobile device.

With Wi-Fi Direct, you can connect your printer to a Wi-Fi Direct network while concurrently connecting to an access point. You can also use a wired network and a Wi-Fi Direct network simultaneously so multiple users can access and print documents both from Wi-Fi Direct and from a wired network.



- You cannot connect your mobile device to the internet through the printer's Wi-Fi Direct.
- The supported protocol list may differ from your model, Wi-Fi Direct networks do NOT support IPv6, network filtering, IPSec, WINS, and SLP services.
- The maximum number of devices that can be connected via Wi-Fi Direct is 4.

Setting up Wi-Fi Direct

You can enable Wi-Fi Direct feature by one of the following methods.

Wireless network setup

From the network-connected computer

If your printer is using a network cable or a wireless access point, you can enable and configure Wi-Fi Direct from SyncThru™ Web Service.

- Access **SyncThru™ Web Service**, select **Settings > Network Settings > Wireless > Wi-Fi Direct**.
- Enable or disable **Wi-Fi Direct** and set other options.

Setting up the mobile device

- After setting up Wi-Fi Direct from the printer, refer to the user manual of the mobile device you are using to set its Wi-Fi Direct.
- After setting up Wi-Fi Direct, you need to download the mobile printing application (For example: Samsung Mobile printer) to print from your smartphone.



- When you have found the printer you want to connect to from your mobile device, select the printer and the printer's LED will blink. Press the WPS button on the printer and it will be connected to your mobile device.
- If your mobile device does not support Wi-Fi Direct, you need to enter the "Network Key" of a printer instead of pushing the WPS button.

Troubleshooting

Problems during setup or driver installation

Printers Not Found

- Your machine may not be turned on. Turn on your computer and the machine.
- USB cable is not connected between your computer and machine. Connect the machine to your computer using the USB cable.
- The machine does not support wireless networking. Check the machine's user's guide included on the software CD supplied with your machine and prepare a wireless network machine.

Connecting Failure - SSID Not Found

- The machine is unable to find the network name (SSID) you have selected or entered. Check the network name (SSID) on your access point and try connecting again.
- Your access point is not turned on. Turn on your access point.

Wireless network setup

Connecting Failure - Invalid Security

- Security is not configured correctly. Check the configured security on your access point and machine.

Connecting Failure - General Connection Error

- Your computer is not receiving a signal from your machine. Check the USB cable and your machine's power.

Connecting Failure - Connected Wired Network

- Your machine is connected with a wired network cable. Remove the wired network cable from your machine.

Connecting Failure - Assigning the IP address

- Cycle the power for the access point (or wireless router) and machine.

PC Connection Error

- The configured network address is unable to connect between your computer and machine.
 - For a DHCP network environment
The receives the IP address automatically (DHCP) when computer is configured to DHCP.



If the printing job is not working in DHCP mode, the problem may be caused by the automatically changed IP address. Compare the IP address between

the product's IP address and the printer port's IP address.

How to compare:

- 1 Print the network information report of your printer, and then check the IP address (see "Printing a network configuration report" on page 99).
- 2 Check the printer port's IP address from your computer.
 - a Click the Windows **Start** menu.
 - For Windows 8, from the **Charms**, select **Search > Settings**.
 - b For Windows XP Service Pack 3/Server 2003, select **Printer and Faxes**.
 - For Windows Server 2008/Vista, select **Control Panel > Hardware and Sound > Printers**.
 - For Windows Server 2008 R2, select **Control Panel > Hardware > Devices and Printers**.
 - For Windows 7/ Windows 8, select **Control Panel > Devices and Printers**.
 - c Right-click your machine.
 - d For Windows XP Service Pack 3/2003/2008/Vista, press **Properties**. For Windows 7/ Windows 8 or Windows Server 2008 R2, from context menus, select the **Printer properties**.
If **Printer properties** item has ► mark, you can select other printer drivers connected with selected printer.
 - e Click **Port** tab.
 - f Click **Configure Port..** button.
 - g Check if **Printer Name** or **IP Address:** is the IP address on the network configuration Sheet.
- 3 Change the printer port's IP address if it is different from the network information report's.
If you want to use the software installation CD to change the port IP, connect to a network printer. Then reconnect the IP address.

Wireless network setup

- For a Static network environment

The machine uses the static address when the computer is configured to static address.

For example,

If the computer's network information is as shown below:

- IP address: 169.254.133.42
- Subnet Mask: 255.255.0.0

Then the machine's network information should be as below:

- IP address: 169.254.133.**43**
- Subnet Mask: 255.255.0.0 (Use the computer's subnet mask.)
- Gateway: 169.254.133.1

Other problems

If problems occur while using the machine on a network, check the following:



For information on the access point (or wireless router), refer to its own user's guide.

- You cannot enable wired and wireless networks at the same time.
- Your computer, access point (or wireless router), or machine may not be turned on.

- Check the wireless reception around the machine. If the router is far from the machine or there is an obstacle, you might have difficulty receiving the signal.
- Cycle the power for the access point (or wireless router), machine, and computer. Sometimes cycling the power can recover network communication.
- Check whether firewall software (V3 or Norton) is blocking the communication.

If the computer and the machine are connected on the same network and it cannot be found when searching, firewall software might be blocking the communication. Refer to the user's guide for the software to turn it off and try searching for the machine again.

- Check whether the machine's IP address is allocated correctly. You can check the IP address by printing the network configuration report.
- Check whether the access point (or wireless router) has a configured security (password). If it has a password, refer to the access point (or wireless router) administrator.
- Check the machine's IP address. Reinstall the machine driver and change the settings to connect to the machine on the network. Due to the characteristics of DHCP, the allocated IP address could change if the machine is not used for a long time or if the access point has been reset.

Register the product's MAC address when you configure the DHCP server on the access point (or wireless router). Then you can always use the IP address that is set with the MAC address. You can identify the Mac address of your machine by printing a network configuration report (see "Printing a network configuration report" on page 99).

Wireless network setup

- Check the wireless environment. You might not be able to connect to the network in the infrastructure environment where you need to type in a user's information before connecting to the access point (or wireless router).
- This machine only supports IEEE 802.11 b/g/n and Wi-Fi. Other wireless communication types (e.g., Bluetooth) are not supported.
- You cannot use infrastructure mode at the same time for Samsung wireless network machines.
- The machine is within the range of the wireless network.
- The machine is located away from obstacles that could block the wireless signal.

Remove any large metal objects between the access point (or wireless router) and the machine.

Make sure the machine and wireless access point (or wireless router) are not separated by poles, walls, or support columns containing metal or concrete.

- The machine is located away from other electronic devices that may interfere with the wireless signal.
Many devices can interfere with the wireless signal, including a microwave oven and some Bluetooth devices.
- Whenever the configuration of your access point (or wireless router) changes, you must do the product's wireless network setup again.
- The maximum number of device that can be connected via **Wi-Fi Direct** is 3.
- If **Wi-Fi Direct** is **ON**, this machine only supports IEEE 802.11 b/g.
- If the access point is set to work with the 802.11n standard only, it may not connect to your machine.

Samsung Mobile Print

What is Samsung Mobile Print?

Samsung Mobile Print is a free application that enables users to print photos, documents, and web pages directly from your smartphone or tablet. **Samsung Mobile Print** is not only compatible with your Android and iOS smart phones but also with your iPod Touch and tablet PC. It connects your mobile device to a network connected Samsung printer or to a wireless printer through a Wi-Fi access point. Installing a new driver or configuring network settings isn't necessary – just simply install the **Samsung Mobile Print** application, and it will automatically detect compatible Samsung printers. Besides printing photos, web pages, and PDFs, scanning is also supported. If you have a Samsung multifunction printer, scan any document into a JPG, PDF, or PNG format for quick and easy viewing on your mobile device.

Downloading Samsung Mobile Print

To download **Samsung Mobile Print**, go to the application store (Samsung Apps, Play Store, App Store) on your mobile device, and just search for "**Samsung Mobile Print**." You can also visit iTunes for Apple devices on your computer.



Android



iOS

Supported Mobile OS

- Android OS 2.3 or higher
- iOS 4.0 or higher

Using the NFC feature

The NFC (Near Field Communication) printer allows you to directly print from your cell phone just by holding your cell phone over the NFC tag on your printer. It does not require installing print driver or connecting to an access point. You just need NFC supported cell phone. In order to use this feature, Samsung Mobile Print app needs to be installed on your cell phone.



- Depending on the material of the cell phone cover, NFC recognition may not work properly.
- Depending on the cell phone you are using, the transmission speed may differ.

Requirements

- NFC and Wi-Fi Direct enabled, Mobile Print app installed cell phone with Android OS 4.0 or higher.



Only Android OS 4.1 or higher will automatically enable the Wi-Fi Direct feature on your cell phone when you enable the NFC feature. We recommend you to upgrade your cell phone to Android OS 4.1 or higher to use the NFC feature.

- Wi-Fi Direct feature enabled printer. Wi-Fi Direct feature is enabled by default.

Printing

- 1 Check that NFC and Wi-Fi Direct feature are enabled on your cell phone and Wi-Fi Direct feature is enabled on your printer (see "Setting up Wi-Fi Direct" on page 121).
- 2 Tag the NFC antenna on your cell phone (usually located on the back of the cell phone) over the NFC tag (NFC) on your printer.

Wait few seconds for the Samsung Mobile Print app to start.

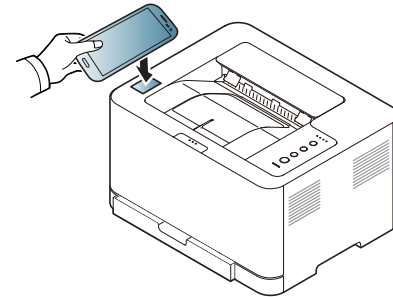

- For some cell phones, NFC antenna might not be located at the back of the cell phone. Check the location of the NFC antenna on your cell phone before tagging.
- If error message about changed PIN number appears, enter a changed PIN number and press OK. Follow the instruction on the app screen to update the PIN number.
- If you do not have Samsung Mobile Print app installed on your cell phone, it automatically connects to Samsung Mobile Print app download page. Download the app and try again.

Using the NFC feature

- 3 Select the content you want to print.

If necessary, change the print option by pressing the .

- 4 Tag the NFC antenna on your cell phone(usually located on the back of the cell phone) over the NFC tag() on your printer.

Wait few seconds for the cell phone to connect to the printer.

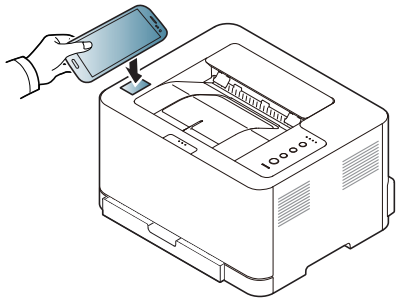

-  For some cell phones, NFC antenna might not be located at the back of the cell phone. Check the location of the NFC antenna on your cell phone before tagging.
- If error message about changed PIN number appears, enter a changed PIN number and press OK. Follow the instruction on the app screen to update the PIN number.

- 5 The printer starts printing.

Registering Google Cloud Printer

- 1 Check that NFC and Wi-Fi Direct features are enabled on your mobile device and Wi-Fi Direct feature is enabled on your printer.

- 2 Tag the NFC tag on your mobile device (usually located on the back of the mobile device) over the NFC tag() on your printer.

Wait a few seconds for the **Samsung Mobile Print** app to start.

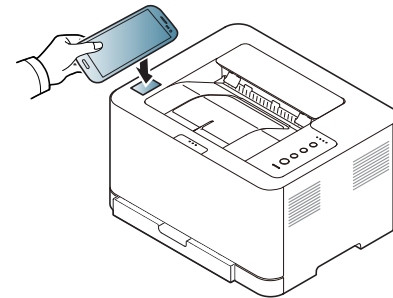

-  For some mobile devices, NFC tag might not be located at the back of the mobile device. Check the location of the NFC antenna on your mobile device before tagging.
- If error message about changed PIN number appears, enter a changed PIN number and press **OK**. Follow the instruction on the app screen to update the PIN number.
- If your do not have **Samsung Mobile Print** app installed on your mobile devices, it automatically connects to **Samsung Mobile Print** app download page. Download the app and try again.

Using the NFC feature

- 3 Select device status icon.
- 4 Select **Google Cloud Print** > **Register Google Cloud Printer**.
- 5 Tag the NFC tag on your mobile device (usually located on the back of the mobile device) over the NFC tag (NFC) on your printer.

Wait a few seconds for the mobile device to connect to the printer.

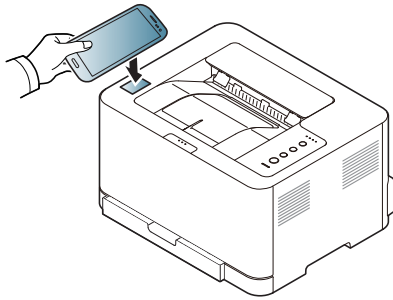

- For some mobile devices, NFC tag might not be located at the back of the mobile device. Check the location of the NFC antenna on your mobile device before tagging.
- If error message about changed PIN number appears, enter a changed PIN number and press **OK**. Follow the instruction on the app screen to update the PIN number.

- 6 Confirm your printer in pop-up window.
Now your printer is registered with Google Cloud Print™ service



Only Mopria-certified machines can use the Mopria feature. Check the box that your machine came in for the Mopria-certified logo.



Mopria™ Print Service is a mobile printing solution that enhances the new print functionality on any Android phone or tablet (Android version 4.4 or later). With this service, you can connect and print to any Mopria-certified printer on the same network as your mobile device without additional set-up. Many native Android apps support printing, including Chrome, Gmail, Gallery, Drive and Quickoffice.

Setting up the machine for Mopria printing

Bonjour(mDNS) and IPP protocols are required on your machine to use the **Mopria** feature. Perform the following steps to enable the **Mopria** feature.

- 1 Ensure that the machine is connected to the network.
- 2 On your computer, open a web browser (Internet Explorer, Safari, or Firefox) and type the IP address of the machine in the address bar. Then, press Enter.

For example,



- 3 Click **Login** in the upper right corner of the SyncThru™ Web Service website.
- 4 If it's your first time logging into **SyncThru™ Web Service** you need to log-in as an administrator. Type in the below default **ID** and **Password**. We recommend you to change the default password for security reasons.
 - **ID: admin**
 - **Password: sec00000**
- 5 When the SyncThru™ Web Service window opens, click **Settings** > **Network Settings** > **Standard TCP/IP, LPR, IPP** > **IPP**. Then, select **Enable**.
- 6 Click **Settings** > **Network Settings** > **mDNS**. Then, select **Enable**.
- 7 Click **Security** > **System Security** > **Feature Management** > **Mopria**. Then, select **Enable**.

Setting up Mopria on your mobile device

If you do not have **Mopria Print Service** app installed on your mobile device, open to the app store (Play Store, App Store) on your mobile device, search for **Mopria Print Service**, and then download and install the app.

- 1 In the **Settings** menu of your Android device, tap **Printing**.



The location of this option may differ depending on your mobile device. If you cannot locate the **Printing** option, refer to the user's manual for your mobile device.

- 2 Under **Print Services**, tap **Mopria Print Service**.
- 3 Tap the **On/Off** slider to enable the **Mopria Print Service**.

Printing via Mopria

To print via Mopria on an Android device:

- 1 Open the email, photo, web page, or document that you want to print.
- 2 Tap **Print** on the menu in the app.
- 3 Select **your printer**, and then configure the print options.
- 4 Touch **Print** again to print the document.



To cancel a print job: Select and delete the document from the print queue in the **Notification Bar**.

AirPrint



Only AirPrint certified machines can use the AirPrint feature. Check the box your machine came in for the AirPrint certified mark.



AirPrint allows you to wirelessly print directly from iPhone, iPad and iPod touch running the latest version of iOS.

Setting up AirPrint

Bonjour(mDNS) and IPP protocols are required on your machine to use the **AirPrint** feature. You can enable the **AirPrint** feature by one of the following methods.

- 1 Check whether the machine is connected to the network.
- 2 Start a web browser such as Internet Explorer, Safari, or Firefox and enter your machine's new IP address in the browser window.

For example,

A screenshot of a web browser's address bar showing the URL "http://192.168.1.133/".

http://192.168.1.133/

- 3 Click **Login** in the upper right of the SyncThru™ Web Service website.

- 4 If it's your first time logging into **SyncThru™ Web Service** you need to log-in as an administrator. Type in the below default **ID** and **Password**. We recommend you to change the default password for security reasons.

- **ID: admin**
- **Password: sec00000**

- 5 When the **Embedded Web Service** window opens, click **Settings > Network Settings**.

- 6 Click **Raw TCP/IP, LPR, IPP** or **mDNS**.

You can enable the IPP protocol or mDNS protocol.

AirPrint

Printing via AirPrint

For example, the iPad manual provides these instructions:

- 1 Open your email, photo, web page, or document you want to print.
- 2 Touch the action icon().
- 3 Select **your printer driver name** and option menu to set up.
- 4 Touch **Print** button. Print it out.



Cancelling print job: To cancel the printing job or view the print summary, click the print center icon () in multitasking area. You can click cancel in the print center.

Samsung Cloud Print

Samsung Cloud Print is a free cloud service that allows you to print or scan from your smartphone or tablet to your Samsung printer or MFP. After installing the Samsung Cloud Print app, you can register with the Samsung Cloud Print service just using your mobile number for authentication. No other account login is required, although you can link the app to your Samsung Account if you wish.



If you press the () button from Samsung Cloud Print app, Your mobile device and printer or MFP can be paired , QR code, or by manually entering its MAC address. Once paired, you can print or scan from anywhere and everywhere.

Registering your Printer to Samsung Cloud server

Registering from Web Browser



Make sure the printer machine is turned on and connected to a wired or wireless network that has access to the Internet.

- 1 Open Web browser.
- 2 Enter your printer's IP address in the address field and press the Enter key or click **Go**.

- 3 Click **Login** in the upper right corner of the SyncThru™ Web Service website.
- 4 If it's your first time logging into **SyncThru™ Web Service** you need to log-in as an administrator. Type in the below default **ID** and **Password**. We recommend you to change the default password for security reasons.
 - **ID: admin**
 - **Password: sec00000**



If you want to create a new user or change the password, see "Security tab" on page 162.

- 5 When the **SyncThru™ Web Service** window opens, click **Settings** > **Network Settings** > **Samsung Cloud Print**.
- 6 Enable Samsung Cloud Print Protocol.
- 7 Now your printer is registered with Samsung Cloud Print service.

Samsung Cloud Print

Printing with Samsung Cloud Print



Make sure the printer is turned on and connected to a wired or wireless network that has access to the Internet.

Registering a printer from an application on mobile device

The following steps are an example of using the **Samsung Cloud Print** app from Android mobile phone.

- 1 Open **Samsung Cloud Print** app.



If you do not have **Samsung Cloud Print** app installed on your cellphone, go to the application store (Samsung Apps, Play Store, App Store) on your mobile device, and just search for download the app and try again.

- 2 Press the () button from Samsung Cloud Print app.
- 3 Your mobile device and printer or MFP can be paired NFC tapping, QR code or by manually entering its MAC address.

Printing from an application on mobile device

The following steps are an example of using the **Samsung Cloud Print** app from Android mobile phone.

- 1 Open **Samsung Cloud Print** app.



If you do not have **Samsung Cloud Print** app installed on your cellphone, go to the application store (Samsung Apps, Play Store, App Store) on your mobile device, and just search for download the app and try again.

- 2 Tap the option check button of the document that you want to print.
- 3 Set the printing options if you want.
- 4 Tap **Send Job**.

Google Cloud Print™

Google Cloud Print™ is a service that allows you to print to a printer using your smart phone, tablet, or any other web-connected devices. Just register your Google account with the printer, and you are ready to use the Google Cloud Print service. You can print your document or email with Chrome OS, Chrome browser, or a Gmail™/ Google Docs™ application on your mobile device, so you don't need to install the printer driver on the mobile device. Refer to the Google website (<http://support.google.com/cloudprint>) for more information about Google Cloud Print.

Registering your Google account to the printer



- Make sure the printer machine is turned on and connected to a wired or wireless network that has access to the Internet.
- You should create your Google account in the advance.

- 1 Open the Chrome browser.
- 2 Visit www.google.com.
- 3 Sign in to the Google website with your Gmail address.
- 4 Enter your printer's IP address in the address field and press the Enter key or click **Go**.

5 Click **Login** in the upper right corner of the SyncThru™ Web Service website.

6 If it's your first time logging into **SyncThru™ Web Service** you need to log-in as an administrator. Type in the below default **ID** and **Password**. We recommend you to change the default password for security reasons.

- **ID: admin**
- **Password: sec00000**



If the network environment is using a proxy server, you need to configure the proxy's IP and port number from **Settings > Network Settings > Google Cloud Print > Proxy Setting**. Contact your network service provider or network administrator for more information.

7 When the **SyncThru™ Web Service** window opens, click **Settings > Network Settings > Google Cloud Print**.

8 Enter your printer's name and description.

9 Click **Register**.
The confirmation pop-up window appears.



If you set the browser to block pop-ups, the confirmation window will not appear. Allow the site to show pop-ups.

Google Cloud Print™

10 Click **Finish printer registration**.

11 Click **Manage your printers**.

Now your printer is registered with Google Cloud Print service.

Google Cloud Print-ready devices will appear in the list.

Printing with Google Cloud Print™

The printing procedure varies depending on the application or the device you are using. You can see the application list that supports Google Cloud Print service.



Make sure the printer is turned on and connected to a wired or wireless network that has access to the Internet.

Printing from an application on mobile device

The following steps are an example of using the Google Docs app from Android mobile phone.

1 Install the Cloud Print application on your mobile device.



If you do not have the application, download it from the application store such as Android Market or App Store.

2 Access the Google Docs application from your mobile device.

3 Tap the option  button of the document that you want to print.

4 Tap the send  button.

5 Tap the Cloud Print  button.

6 Set the printing options if you want.

7 Tap **Click here to Print**.

Printing from the Chrome browser

The following steps are an example of using the Chrome browser.

- 1 Run Chrome.
- 2 Open the document or email that you want to print.
- 3 Click the wrench icon  in the browser's top right corner.
- 4 Click **Print**. A new tab for printing appears.
- 5 Select **Print with Google Cloud Print**.
- 6 Click the **Print** button.



3. Special Features

This chapter explains special printing features.

- **Altitude adjustment** 140
- **Printing features** 141



The procedures in this chapter are mainly based on Windows 7.

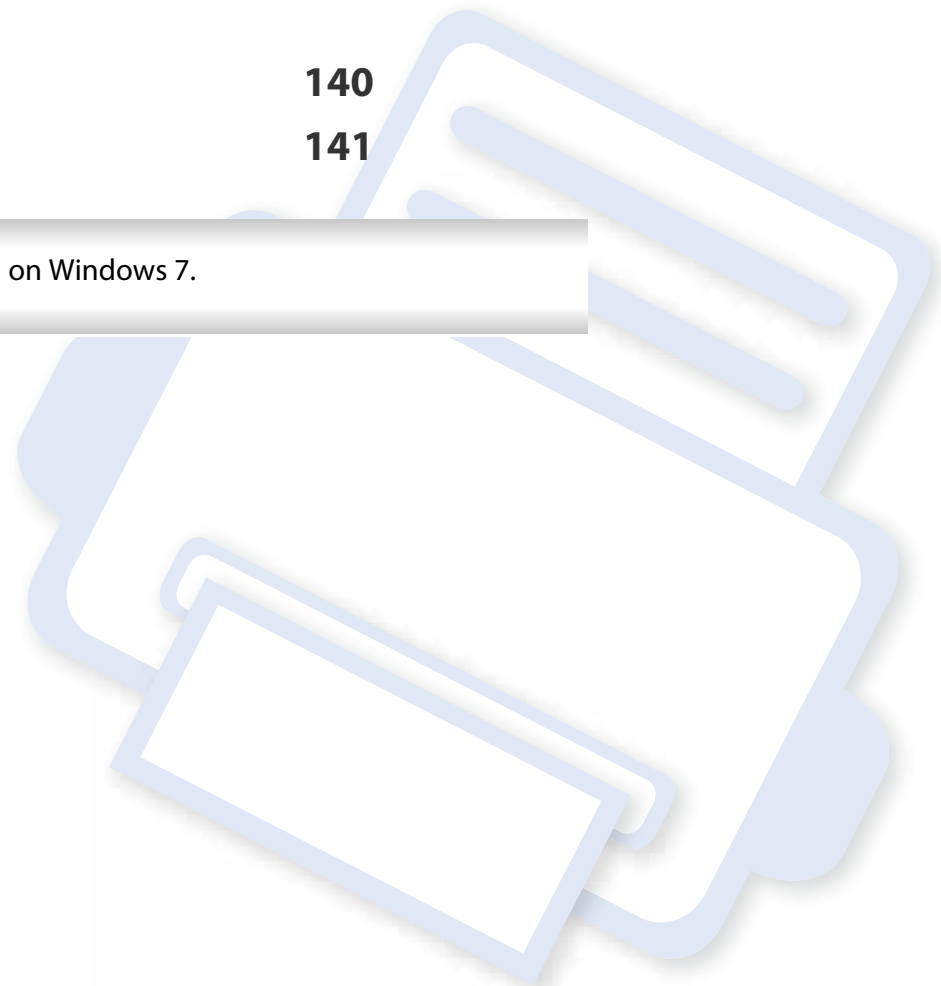

Altitude adjustment

Print quality is affected by atmospheric pressure, which is determined by the height of the machine above sea level. The following information will guide you on how to set your machine for the best print quality.

Before you set the altitude value, determine the altitude where you are.

- **Normal:** 0-1,000 m(3,280 ft)
- **High1:** 1,000 m(3,280 ft)-2,000 m(6,561 ft)
- **High2:** 2,000 m(6,561 ft)-3,000m(9,842 ft)
- **High3:** 3,000 m(9,842 ft)-4,000 m(13,123 ft)
- **High4:** 4,000 m(13,123 ft)-5,000 m(16,404 ft)
- For Windows and Mac users, you set from **Samsung Easy Printer Manager** > **Advanced Setting** > **Device Settings**. See "Using Samsung Easy Printer Manager" on page 164.



If your machine is connected to the network, you can set the altitude via SyncThru™ Web Service (see "Using SyncThru™ Web Service" on page 161).

Printing features



- For basic printing features, refer to the Basic Guide (see "Basic printing" on page 36).
- This feature may not be available depending on model or optional goods (see "Features by model" on page 6).

Changing the default print settings

- 1 Click the Windows **Start** menu.
 - For Windows 8, from the **Charms**, select **Search** > **Settings**.
- 2 For Windows XP/Server 2003, select **Printer and Faxes**.
 - For Windows Server 2008/Vista, select **Control Panel** > **Hardware and Sound** > **Printers**.
 - For Windows Server 2008 R2, select **Control Panel** > **Hardware** > **Devices and Printers**.
 - For Windows 7/8, select **Control Panel** > **Devices and Printers**.
- 3 Right-click on your machine.
- 4 For Windows XP/Server 2003/Server 2008/Vista, select **Printing Preferences**.
For Windows 7/8 or Windows Server 2008 R2, from context menus, select **Printing preferences**.



If **Printing preferences** has a ►, you can select other printer drivers connected to the selected printer.

- 5 Change the settings on each tab.
- 6 Click **OK**.



If you want to change the settings for each print job, change it in **Printing Preferences**.

Setting your machine as a default machine

- 1 Click the Windows **Start** menu.
 - For Windows 8, from the **Charms**, select **Search** > **Settings**.
- 2 For Windows XP/Server 2003, select **Printer and Faxes**.
 - For Windows Server 2008/Vista, select **Control Panel** > **Hardware and Sound** > **Printers**.
 - For Windows Server 2008 R2, select **Control Panel** > **Hardware** > **Devices and Printers**.
 - For Windows 7/8, select **Control Panel** > **Devices and Printers**.

Printing features

- 3 Select your machine.
- 4 Right-click your machine and select **Set as Default Printer**.

 For Windows 7 or Windows Server 2008 R2, if **Set as default printer** has a ►, you can select other printer drivers connected to the selected printer.

Using advanced print features

-  **XPS printer driver:** used to print XPS file format.
- See "Features by model" on page 6.
 - The XPS printer driver can be installed only on Windows Vista OS or higher.
 - For models that provide XPS driver from the Samsung website, <http://www.samsung.com> > find your product > Support or downloads.

Printing to a file (PRN)

You will sometimes need to save the print data as a file.

- 1 Check the **Print to file** box in the **Print** window.

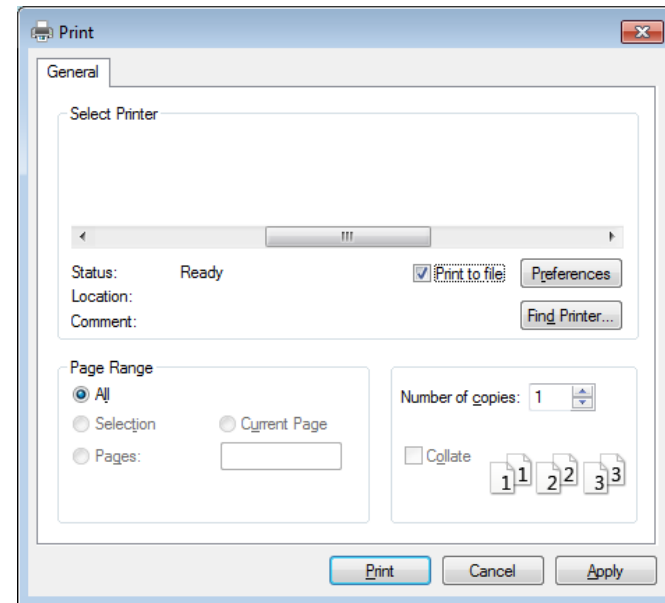

- 2 Click **Print**.
- 3 Type in the destination path and the file name, and then click **OK**.
For example, **c:\Temp\file name**.

 If you type in only the file name, the file is automatically saved in **My Documents, Documents and Settings, or Users**. The saved folder may differ, depending on your operating system or the application you are using.

Printing features

Understanding special printer features

You can use advanced printing features when using your machine.



To take advantage of the printer features provided by your printer driver, click **Properties** or **Preferences** in the application's **Print** window to change the print settings. The machine name that appears in the printer properties window may differ depending on the machine in use.



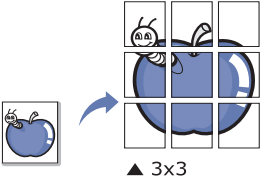
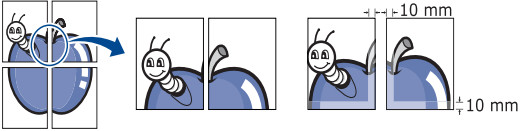
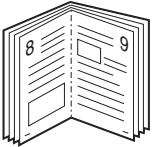

- Some menus may not appear on the display depending on options or models. If so, it is not applicable to your machine.
- Select the **Help** menu or click the  button from the window or press **F1** on your keyboard and click on any option you want to know about (see "Using help" on page 39).

Item	Description
<p data-bbox="51 815 315 887">Multiple Pages per Side</p>  An icon showing two pages of a document, labeled '1' and '2', representing multiple pages per side.	<p data-bbox="383 815 2175 887">Selects the number of pages to print on a single sheet of paper. To print more than one page per sheet, the pages will be reduced in size and arranged in the order you specify. You can print up to 16 pages on one sheet.</p>

Printing features

Item	Description
<p>Poster Printing</p> 	<p>Prints a single-page document onto 4 (Poster 2x2), 9 (Poster 3x3), or 16 (Poster 4x4) sheets of paper, for the purpose of pasting the sheets together to form one poster-size document.</p> <p>Select the Poster Overlap value. Specify Poster Overlap in millimeters or inches by selecting the radio button on the upper right of Basic tab to make it easier to paste the sheets together.</p> 
<p>Booklet Printing</p> 	<p>Prints your document on both sides of a sheet of paper and arranges the pages so that the paper can be folded in half after printing to produce a booklet.</p> <ul style="list-style-type: none">• This option is available only when you use the PCL/SPL printer driver. This option is not available when you use XPS driver.• The Booklet Printing option is not available for all paper sizes. Select the available paper Size option under the Paper tab to see what paper sizes are available.• If you select an unavailable paper size, this option can be automatically canceled. Select only available paper (paper without  or  mark).

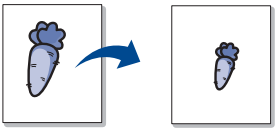

Printing features

Item	Description
Double-sided Printing (Manual)	<p>Print on both sides of a sheet of paper (duplex). Before printing, decide how you want your document oriented.</p> <div data-bbox="383 355 2197 603" style="background-color: #f0f0f0; padding: 10px;"><ul style="list-style-type: none">This option is available only when you use the PCL/SPL printer driver. This option is not available when you use XPS driver.If your machine does not have a duplex unit, you should complete the printing job manually. The machine prints every other page of the document first. After that, a message appears on your computer.Skip Blank Pages feature does not work when you select the duplex option.</div> <ul style="list-style-type: none">None: Disables this feature.Long Edge: This option is the conventional layout used in bookbinding. Short Edge: This option is the conventional layout used in calendars. 
Paper Options 	<p>Changes the size of a document to appear larger or smaller on the printed page by entering in a percentage by which to enlarge or decrease the document.</p>

Printing features

Item	Description
Watermark 	<p>The watermark option allows you to print text over an existing document. For example, you use it when you want to have large gray letters reading "DRAFT" or "CONFIDENTIAL" printed diagonally across the first page or all pages of a document.</p>
Watermark (Creating a watermark)	<ul style="list-style-type: none">a To change the print settings from your software application, access Printing Preferences (see "Opening Printing Preferences" on page 37).b From the Advanced tab, select Edit... from the Watermark drop-down list.c Enter a text message in the Watermark Message box. You can enter up to 256 characters. When the First Page Only box is checked, the watermark prints on the first page only.d Select watermark options. You can select the font name, style, size, and shade from the Font Attributes section, as well as set the angle of the watermark from the Watermark Alignment and Angle section.e Click Add to add a new watermark to the Current Watermarks list.f When you finish editing, click OK or Print until you exit the Print window.
Watermark (Editing a watermark)	<ul style="list-style-type: none">a To change the print settings from your software application, access Printing Preferences (see "Opening Printing Preferences" on page 37).b Click the Advanced tab, select Edit... from the Watermark drop-down list.c Select the watermark you want to edit from the Current Watermarks list and change the watermark message and options.d Click Update to save the changes.e Click OK or Print until you exit the Print window.
Watermark (Deleting a watermark)	<ul style="list-style-type: none">a To change the print settings from your software application, access Printing Preferences.b Click the Advanced tab, select Edit... from the Watermark drop-down list.c Select the watermark you want to delete from the Current Watermarks list and click Delete.d Click OK or Print until you exit the Print window.

Printing features

Item	Description
<p data-bbox="53 392 174 427">Overlay^a</p>  <p>The diagram shows a square box containing the letter 'A' on the left. An arrow points to the right, where a document page is shown. The page has a header area containing the letter 'A' and the text 'WORLD B B B B' below it. This illustrates how a separate overlay document is used to print content onto a specific part of a document page.</p>	<p data-bbox="380 272 1928 304">This option is available only when you use the PCL/SPL printer driver. This option is not available when you use XPS driver</p> <p data-bbox="380 328 2159 485">An overlay is text and/or images stored in the computer hard disk drive (HDD) as a special file format that can be printed on any document. Overlays are often used to take the place of letterhead paper. Rather than using preprinted letterhead, you can create an overlay containing exactly the same information that is currently on your letterhead. To print a letter with your company's letterhead, you do not need to load preprinted letterhead paper in the machine: just print the letterhead overlay on your document.</p> <p data-bbox="380 509 1529 541">To use a page overlay, you must create a new page overlay containing your logo or image.</p> <div data-bbox="380 592 2204 751" style="background-color: #f0f0f0; padding: 10px;"><ul data-bbox="477 624 2197 703" style="list-style-type: none">• The overlay document size must be the same as the document you print with the overlay. Do not create an overlay with a watermark.• The resolution of the overlay document must be the same as that of the document you will print with the overlay.</div>
<p data-bbox="53 935 344 1062">Overlay^a (Creating a new page overlay)</p>	<ol data-bbox="380 788 2197 1206" style="list-style-type: none">a Create or open a document containing text or an image for use in a new page overlay. Position the items exactly as you wish them to appear when printed as an overlay.b To save the document as an overlay, access Printing Preferences.c Click the Advanced tab, and select Create from the Overlay drop-down list.d In the Save As window, type a name up to eight characters in the File name box. Select the destination path, if necessary (The default is C:\Formover).e Click Save.f Click OK or Print until you exit the Print window. When a confirming message window appears, click Yes.g The file is not printed. Instead, it is stored on your computer hard disk drive.

Printing features

Item	Description
Overlay^a (Using a page overlay)	<ul style="list-style-type: none">a Create or open the document you want to print.b To change the print settings from your software application, access Printing Preferences.c Click the Advanced tab.d Select the Print Overlay from the Overlay drop-down list.e If the overlay file you want does not appear in the Overlay File 1 or Overlay File 2 drop-down list, select Load from the Overlay List. Select the overlay file you want to use. If you have stored the overlay file you want to use in an external source, you can also load the file when you access the Load window. After you select the file, click Open. The file appears in the Overlay List box and is available for printing. Select the overlay from the Overlay List box.f If necessary, check Confirm Page Overlay When Printing box. If this box is checked, a message window appears each time you submit a document for printing, asking you to confirm your wish to print an overlay on your document. If this box is not checked and an overlay has been selected, the overlay automatically prints with your document.g Click OK or Print until you exit the Print window. The selected overlay prints on your document.
Overlay^a (Deleting a page overlay)	<ul style="list-style-type: none">a In the Printing Preferences window, click the Advanced tab.b Select Edit in the Text drop down list.c Select the overlay you want to delete from the Overlay List box.d Click Delete.e When a confirming message window appears, click Yes.f Click OK or Print until you exit the Print window. You can delete page overlays that you no longer use.

a. This option is not available when you use XPS driver.

Printing features

Mac printing



Some features may not be available depending on models or options. It means that the features are not supported.

Printing a document

When you print with a Mac, you need to check the printer driver settings in each application you use. Follow the steps below to print from a Mac:

- 1 Open the document to print.
- 2 Open the **File** menu and click **Page Setup** (**Document Setup** in some applications).
- 3 Choose your paper size, orientation, scaling, other options, and make sure that your machine is selected. Click **OK**.
- 4 Open the **File** menu and click **Print**.
- 5 Choose the number of copies and indicate which pages to print.
- 6 Click **Print**.

Changing printer settings

You can use advanced printing features when using your machine.

Open an application and select **Print** from the **File** menu. The machine name, which appears in the printer properties window, may differ depending on the machine in use. Except for the name, the composition of the printer properties window is similar to the following.

Printing multiple pages on one sheet

You can print more than one page on a single sheet of paper. This feature provides a cost-effective way to print draft copies.

- 1 Open an application, and select **Print** from the **File** menu.
- 2 Select **Layout** from the drop-down list under **Orientation**. In the **Pages per Sheet** drop-down list, select the number of pages you want to print on one sheet of paper.
- 3 Select the other options to use.
- 4 Click **Print**.
The machine prints the selected number of pages to print on one sheet of paper.

Printing features

Printing on both sides of the paper



Some features may not be available depending on models or options. It means that the features are not supported (see "Variety feature" on page 8).

Before printing in the duplex mode, decide on which edge you will be binding your finished document. The binding options are, as follows:

- **Long-Edge Binding:** This option is the conventional layout used in book binding.
- **Short-Edge Binding:** This option is the type often used with calendars.

- 1 From your Mac application, select **Print** from the **File** menu.
- 2 Select **Layout** from the drop-down list under **Orientation**.
- 3 Select a binding orientation from the **Two-Sided** option.
- 4 Select the other options to use.
- 5 Click **Print** and the machine prints on both sides of the paper.



If you print more than 2 copies, the first copy and the second copy might print on the same sheet of paper. Avoid printing on both sides of paper when you are printing more than 1 copy.

Using help

Click the question mark on the bottom-left corner of the window and click on the topic you want to know about. A pop-up window appears with information about that option's feature, which is provided from the driver.

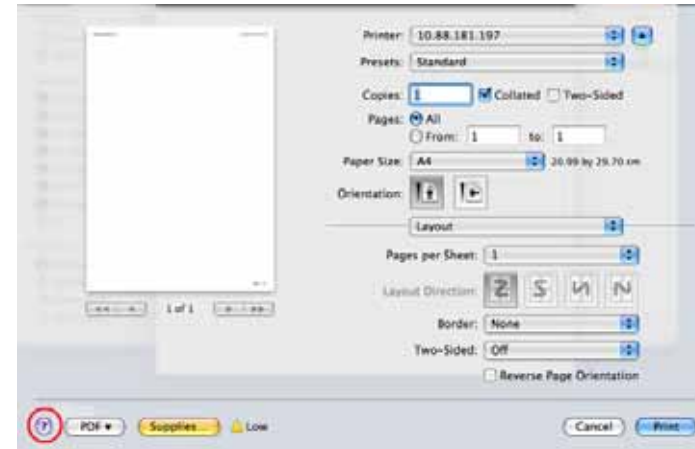

Printing features

Linux printing



Some features may not be available depending on models or options. It means that the features are not supported.

Printing from applications

There are a lot of Linux applications that allow you to print using Common UNIX Printing System (CUPS). You can print on your machine from any such application.

- 1 Open the document to print.
- 2 Open the **File** menu and click **Page Setup (Print Setup** for some applications).
- 3 Choose your paper size, orientation, and make sure that your machine is selected. Click **Apply**.
- 4 Open the **File** menu and click **Print**.
- 5 Select your machine to print.
- 6 Choose the number of copies and indicate which pages to print.

- 7 Change other printing options in each tab, if necessary.
- 8 Click **Print**.



Automatic/manual duplex printing may not be available depending on models. You can alternatively use the lpr printing system or other applications for odd-even printing (see "Features by model" on page 6).

Printing files

You can print text, image, pdf files on your machine using the standard CUPS directly from the command line interface. The CUPS lp or lpr utility allows you to do that. You can print these files by using below command format.

```
"lp -d <printer name> -o <option> <file name>"
```

Please refer to lp or lpr man page on your system for more details.

Printing features

Configuring Printer Properties

You can change the default printing options or connection type with Printing utility supplied by o/s.

- 1** Launch Printing utility(Go to **System > Administration > Printing** menu or execute "**system-config-printer**" command in Terminal program).
- 2** Select your printer and double-click it.
- 3** Change default printing options or connection type.
- 4** Click **Apply** button.



4. Useful Management Tools

This chapter introduces management tools provided to help you make full use of your machine.

- **Accessing management tools** 154
- **Easy Capture Manager** 155
- **Samsung Easy Color Manager** 156
- **Easy Eco Driver** 157
- **Using Samsung Printer Center** 158
- **Using SyncThru™ Web Service** 161
- **Using Samsung Easy Printer Manager** 164
- **Using Samsung Printer Status** 166
- **Using Samsung Printer Experience** 168



Accessing management tools

Samsung provides a variety of management tools for Samsung printers.

- 1 Make sure that the machine is connected to your computer and powered on.
- 2 From the **Start** menu, select **Programs** or **All Programs**.
 - For Windows 8, from the **Charms**, select **Search > Apps**.
- 3 Find **Samsung Printers**.
- 4 Under **Samsung Printers**, you can see installed management tools.
- 5 Click the management tool you want to use.



- After installing the driver, for some management tools, you can access them directly from the **Start** menu > **Programs** or **All Programs**.
- For Windows 8, after installing the driver, for some management tools, you can access them directly from the **Start** screen by clicking on the corresponding tile.

Easy Capture Manager



- This feature may not be available depending on model or optional goods (see "Software" on page 7).
- Available for Windows OS users only (see "Software" on page 7).

Capture your screen and launch Easy Capture Manager by simply pressing the Print Screen key on the keyboard. Now you can easily print your captured screen as captured or edited.

Samsung Easy Color Manager

Samsung Easy Color Manager helps users do fine adjustments with 6 color tones and other properties, such as brightness, contrast, and saturation. Color tone changes can be saved as a profile and can be used from the driver or from inside of the machine.



- This feature may not be available depending on model or optional goods (see "Software" on page 7).
- Available for Windows and Mac OS users only (see "Software" on page 7).

Helps Samsung color laser printer users to adjust color as they like.

Download the software from the Samsung website then unpack and install it: (<http://www.samsung.com> > find your product > Support or Downloads).

Easy Eco Driver



- Available for Windows OS users only (see "Software" on page 7).
- To use the Easy Eco Driver features, the Eco Driver Pack must be installed.

With the Easy Eco Driver, you can apply Eco features to save paper and toner before printing.

Easy Eco Driver also allows you simple editing such as removing images and texts, and more. You can save frequently used settings as a favorite.

How to use:

- 1 Open a document to print.
- 2 Open printing preference window (see "Opening Printing Preferences" on page 37).
- 3 From the **Favorites** tab, select **Eco Printing Preview**.
- 4 Click **OK > Print** in the window. A preview window appears.
- 5 Select the options you want to apply to the document.

You can see the preview of the applied features.

- 6 Click **Print**.



- If you want to run Easy Eco Driver every time you print, check **Start Easy Eco Driver before printing job** checkbox in the **Basic** tab of the printing preference window.
- To use this feature on Stylish User Interface, click **Samsung Printer Center > Device Options** and then select **Stylish User Interface** (see "Using Samsung Printer Center" on page 158).

Using Samsung Printer Center



- Available for Windows users only.

The **Samsung Printer Center** allows you to manage all the printer drivers installed on your computer from a single integrated application. You can use the **Samsung Printer Center** to add and remove printer drivers, check the status of printers, update printer software, and configure printer driver settings.

Understanding Samsung Printer Center

To open the program:

For Windows,

Select **Start > Programs** or **All Programs > Samsung Printers > Samsung Printer Center**.

Printers tab



The screenshot may differ depending on operating system you are using.

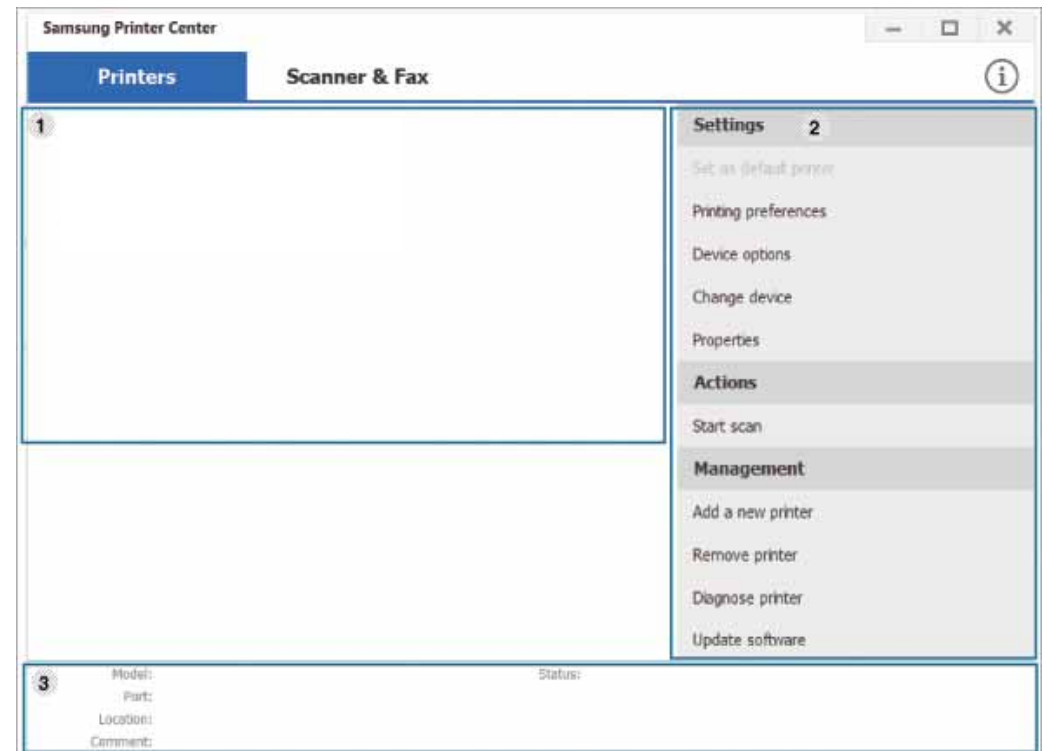

1	Printer list	Displays the printer drivers installed on your computer. To add a printer driver to the list, click the  button.
---	---------------------	---

Using Samsung Printer Center

Quick links

Displays links to various printer driver management functions. The quick links in the **Printers** tab link to the following functions:

- **Settings:** Allows you to configure the settings for individual printer driver.
 - **Set as default printer:** Sets the selected printer driver as the default printer. If the selected printer driver is already set as the default printer, then this option is not activated.
 - **Printing preferences:** Allows you to configure the default print settings.
 - **Device options:** Allows you to configure advanced options, such as the settings for optional devices and additional features.



The option allows you to modify the **Printer Status** and **Stylish User Interface** settings.

- **Change device:** Allows you to change the device into another device.
- **Properties:** Allows you to configure the printer driver properties, such as the name of the printer driver and its location, or add comments about the printer driver .
- **Actions:** Allows you to use the scan feature (this option is enabled only if the selected device supports the scan feature).
- **Management:** Allows you to manage the devices registered in the program.
 - **Add a new printer / Remove printer:** Adds a new device or removes an existing device.
 - **Diagnose printer:** Diagnoses problems in the selected device and suggests solutions.
 - **Update software:** Downloads and applies the applicable software updates.

3

Printer information

Provides general information about the selected device, such as its model, IP address, port number, and status.

Scanner & Fax Tab



- The screenshot may differ depending on operating system you are using.
- Available for multifunction products only.

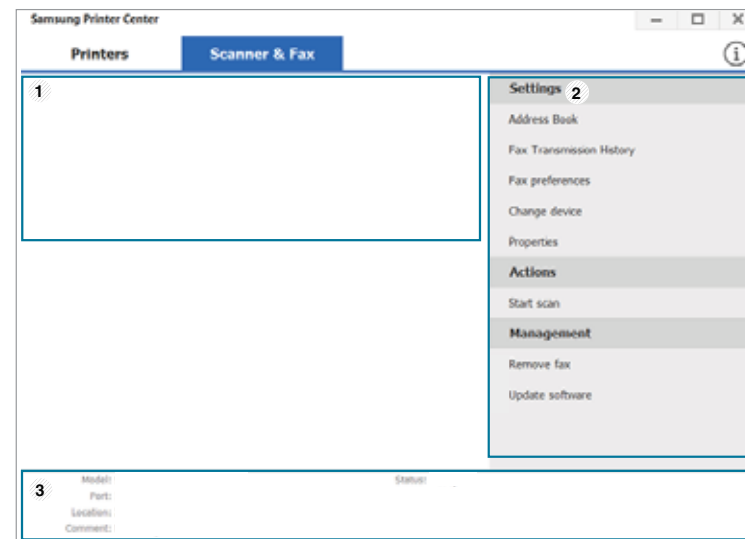

1

Printer list

Displays the fax and scanner driver installed on your computer. To add a fax or scanner driver to the list, click the



(Add Fax)



(Add Scanner) button.

Using Samsung Printer Center

Quick links

Displays links to the functions available for managing fax or scanner drivers. The quick links in the **Scanner & Fax** tab offer the following features:



To use this feature, the scanner driver and fax driver must be installed on the computer.

- **Settings:** Allows you to configure the settings for fax or scanner drivers.
 - **Address Book** (fax only): Opens the Address Book.
 - **Fax Transmission History** (fax only): Opens the fax transmission history.
 - **Fax preferences** (fax only): Allows you to configure the default fax settings.
 - **Change device:** Allows you to change the devices into another device.
 - **Properties:** Allows you to configure the properties of a device, such as location and add comments about the device.
- **Actions:** Allows you to use the scan feature.
- **Management:** Allows you to manage the devices registered in the program.
 - **Remove fax** or **Remove scan:** Removes the selected fax or scan driver.
 - **Update software:** Downloads and applies the applicable software updates.

3

Printer information

Provides general information about the selected device, such as the model, IP address, port number, and machine status.

2

Using SyncThru™ Web Service



- Internet Explorer 6.0 or higher is the minimum requirement for SyncThru™ Web Service.
- SyncThru™ Web Service explanation in this user's guide may differ from your machine depending on its options or models.
- Network model only.

Accessing SyncThru™ Web Service

- 1 Access a web browser, such as Internet Explorer, from Windows.
Enter the machine IP address of your printer (<http://xxx.xxx.xxx.xxx>) in the address field and press the Enter key or click **Go**.
- 2 Your machine's embedded website opens.

Logging into SyncThru™ Web Service

Before configuring options in SyncThru™ Web Service, you need to log-in as an administrator. You can still use SyncThru™ Web Service without logging in but you won't have access to **Settings** tab and **Security** tab.

- 1 Click **Login** on the upper right of the SyncThru™ Web Service website.
- 2 If it's your first time logging into **SyncThru™ Web Service** you need to log-in as an administrator. Type in the below default ID and password. We recommend you to change the default password for security reasons.
 - **ID: admin**
 - **Password: sec00000**

SyncThru™ Web Service overview



Information

Settings

Security

Maintenance



Some tabs may not appear depending on your model.

Using SyncThru™ Web Service

Information tab

This tab gives you general information about your machine. You can check things, such as remaining amount of toner. You can also print reports, such as an error report.

- **Active Alerts:** Shows the alerts that have occurred in the machine and their severity.
- **Supplies:** Shows how many pages are printed and amount of toner left in the cartridge.
- **Usage Counters:** Shows the usage count by print types: simplex and duplex.
- **Current Settings:** Shows the machine's and network's information.
- **Print information:** Prints reports such as system related reports and font reports.

Settings tab

This tab allows you to set configurations provided by your machine and network. You need to log-in as an administrator to view this tab.

- **Machine Settings tab:** Sets options provided by your machine.
- **Network Settings tab:** Shows options for the network environment. Sets options such as TCP/IP and network protocols.

Security tab

This tab allows you to set system and network security information. You need to log-in as an administrator to view this tab.

- **System Security:** Sets the system administrator's information and also enables or disables machine features.
- **Network Security:** Sets settings for IPv4/IPv6 filtering.

Maintenance tab

This tab allows you to maintain your machine by upgrading firmware and setting contact information for sending emails. You can also connect to Samsung website or download drivers by selecting the **Link** menu.

- **Firmware Upgrade:** Upgrade your machine's firmware.
- **Contact Information:** Shows the contact information.
- **Link:** Shows links to useful sites where you can download or check information.

Using SyncThru™ Web Service

Setting the system administrator's information

This setting is necessary for using the e-mail notification option.

- 1 Start a web browser, such as Internet Explorer, from Windows.
Enter the machine IP address (<http://xxx.xxx.xxx.xxx>) in the address field and press the Enter key or click **Go**.
- 2 Your machine's embedded website opens.
- 3 From the **Security** tab, select **System Security** > **System Administrator**
- 4 Enter the name of the administrator, phone number, location, and email address.
- 5 Click **Apply**.

Using Samsung Easy Printer Manager



- Available for Windows and Mac OS users only.
- For Windows, Internet Explorer 6.0 or higher is the minimum requirement for Samsung Easy Printer Manager.

Samsung Easy Printer Manager is an application that combines Samsung machine settings into one location. Samsung Easy Printer Manager combines device settings as well as printing environments, settings/actions and launching. All of these features provide a gateway to conveniently use your Samsung machine. Samsung Easy Printer Manager provides two different user interfaces for the user to choose from: the basic user interface and the advanced user interface. Switching between the two interfaces is easy: just click a button.

Understanding Samsung Easy Printer Manager

To open the program:

For Windows,

Select **Start > Programs** or **All Programs > Samsung Printers > Samsung Easy Printer Manager**.

For Mac,

Open the **Applications** folder > **Samsung** folder > **Samsung Easy Printer Manager**.

The Samsung Easy Printer Manager interface is comprised of various basic sections as described in the table that follows:





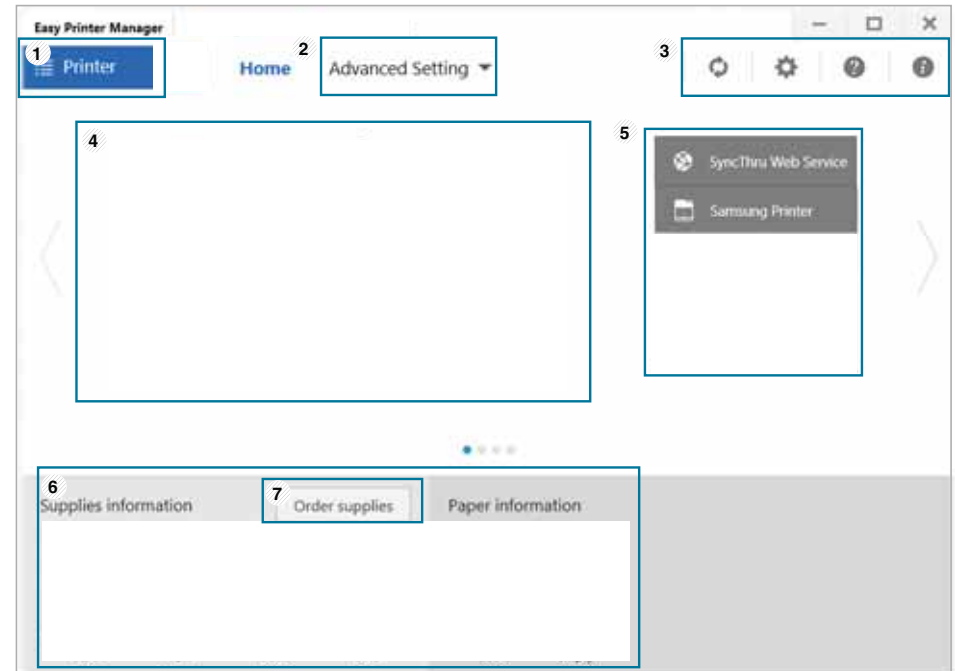

The screenshot may differ depending on operating system you are using.



1	Printer list	The Printer list displays printers installed on your computer and network printers added by network discovery (Windows only).
---	---------------------	---

Using Samsung Easy Printer Manager

<p>2 Advanced Setting</p> <p>The advanced user interface is intended to be used by the person responsible for managing the network and machines.</p> <div data-bbox="309 331 1095 528">  Some menus may not appear in the display depending on options or models. If so, it is not applicable to your machine. </div> <ul style="list-style-type: none"> • Device Settings: You can configure various machine settings such as machine setup, paper, layout, emulation, network, and print information. <div data-bbox="309 715 1095 871">  If you connect your machine to a network, the SyncThru™ Web Service icon is enabled. </div> <ul style="list-style-type: none"> • Alert Settings (Windows only): This menu includes settings related to error alerting. <ul style="list-style-type: none"> - Printer Alert: Provides settings related to when alerts will be received. - Email Alert: Provides options relating to receiving alerts via email. - Alert History: Provides a history of device and toner related alerts.
<p>3 Application information</p> <p>Includes links for changing to the refresh, preference setting, help, and about.</p>

<p>4 Printer information</p> <p>This area gives you general information about your machine. You can check information, such as the machine's model name, IP address (or Port name), and machine status.</p> <div data-bbox="1417 371 2204 568">  This button opens the Troubleshooting Guide when an error occurs. You can directly open the troubleshooting section in the user's guide. </div>
<p>5 Quick links</p> <p>Displays Quick links to machine specific functions. This section also includes links to applications in the advanced settings.</p> <div data-bbox="1417 730 2204 887">  If you connect your machine to a network, the SyncThru™ Web Service icon is enabled. </div>
<p>6 Contents area</p> <p>Displays information about the selected machine, remaining toner level, and paper. The information will vary based on the machine selected. Some machines do not have this feature.</p>
<p>7 Order supplies</p> <p>Click on the Order button from the supply ordering window. You can order replacement toner cartridge(s) from online.</p>



Select the **Help** menu or click the  button from the window and click on any option you want to know about.

Using Samsung Printer Status

The Samsung Printer Status is a program that monitors and informs you of the machine status.





- The Samsung Printer Status window and its contents shown in this user's guide may differ depending on the machine or operating system in use.
- Check the operating system(s) that are compatible with your machine (see "System requirements" on page 73).
- Available for Windows OS users only.

Samsung Printer Status overview

If an error occurs while operating, you can check the error from the Samsung Printer Status. Samsung Printer Status is installed automatically when you install the machine software.

You can also launch Samsung Printer Status manually. Go to the **Printing Preferences**, click the **Basic** tab > **Printer Status** button.

These icons appear on the Windows task bar:

Icon	Mean	Description
	Normal	The machine is in ready mode and experiencing no errors or warnings.
	Warning	The machine is in a state where an error might occur in the future. For example, it might be in toner low status, which may lead to toner empty status.
	Error	The machine has at least one error.

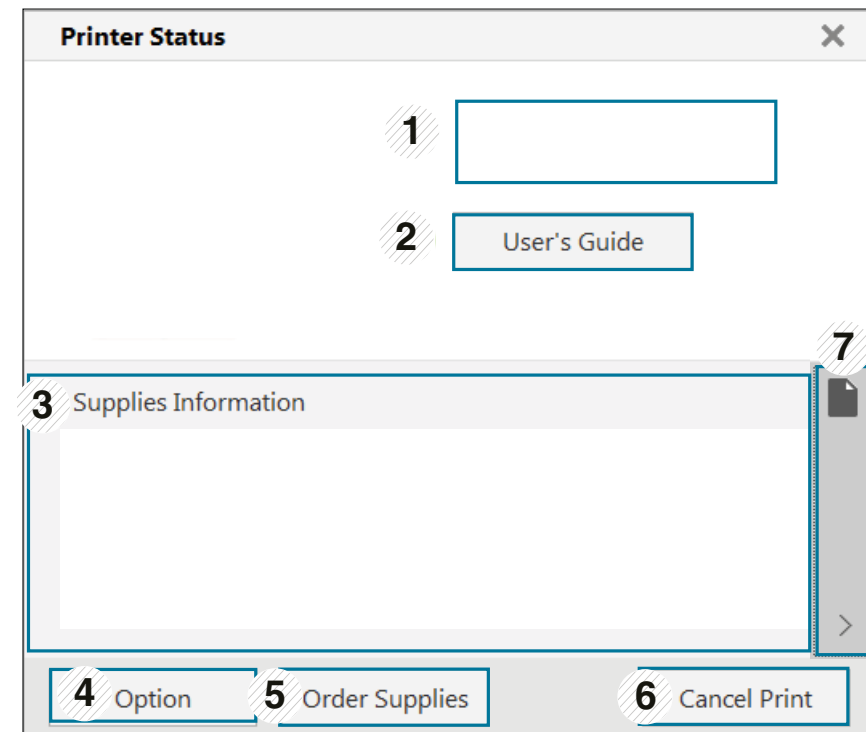

Using Samsung Printer Status

1	Device Information	You can see the device status , current printer model name, connected port name in this area.
2	User's Guide	<p>You can view the online User's Guide.</p> <div style="border: 1px solid #ccc; padding: 10px; margin: 10px 0;">  This button opens the Troubleshooting Guide when an error occurs. You can directly open the troubleshooting section in the user's guide. </div>
3	Supplies Information	You can view the percentage of toner remaining in each toner cartridge. The machine and the number of toner cartridge(s) shown in the above window may differ depending on the machine in use. Some machines do not have this feature.
4	Option	You can set printing job alert related settings.
5	Order Supplies	You can order replacement toner cartridge(s) from online.
6	Cancel Print or Close	<ul style="list-style-type: none"> • Cancel Print : If print job is waiting in the print queue or printer, cancel all user's print jobs in the print queue or the printer. • Close : Depending on the status of the machine or the supported functions, the Close button may appear to close the status window.

7	Toner/Paper Information	This button areas for paper and toner info will be available based on the device.
---	--------------------------------	---

Using Samsung Printer Experience

Samsung Printer Experience is a Samsung application that combines Samsung machine settings and machine management into one location. You can set device settings, order supplies, open troubleshooting guides, visit Samsung's web site, and check connected machine information. This application will be automatically downloaded from the Windows **Store** if the machine is connected to a computer with an Internet connection.

Understanding the Samsung Printer Experience

To open the application,

From the **Start** screen, select the **Samsung Printer Experience** () tile.

The **Samsung Printer Experience** interface comprises various useful features as described in the following table:



The screenshot may differ depending on the model you are using.

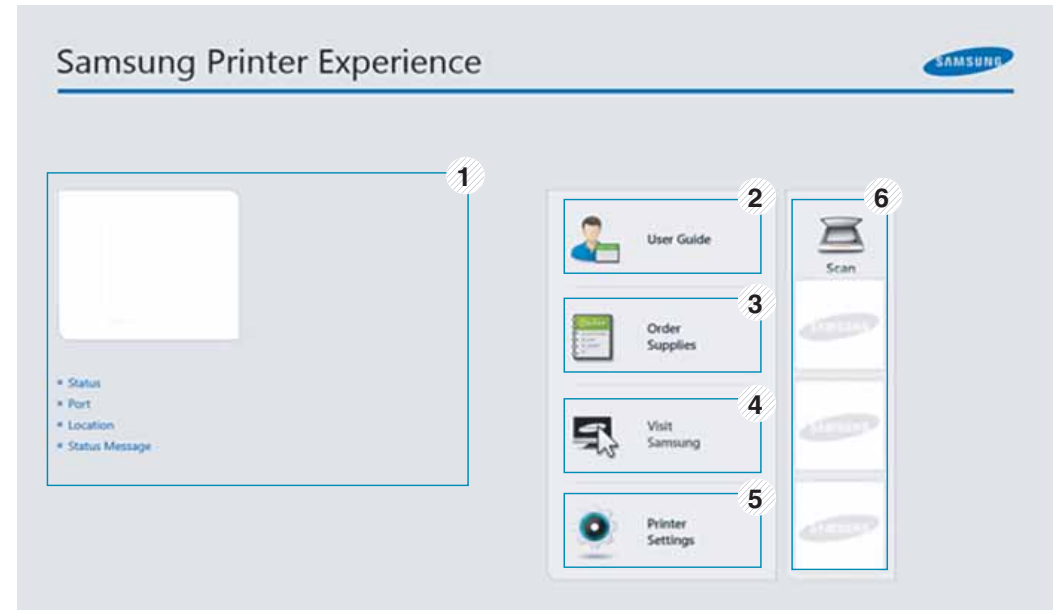

1	Printer Information	This area gives you general information about your machine. You can check information, such as the machine's status, location, IP address, and remaining toner level.
---	----------------------------	---

Using Samsung Printer Experience

2	User's Guide	You can view the online User's Guide. You need to be connected to the Internet to use this feature.  This button opens the Troubleshooting Guide when an error occurs. You can directly open the troubleshooting section in the user's guide.
3	Order Supplies	Click on this button to order replacement toner cartridges online. You need to be connected to the Internet to use this feature.
4	Visit Samsung	Links to Samsung printer website. You need to be connected to the Internet to use this feature.
5	Printer Settings	You can configure various machine settings such as machine setup, paper, layout, emulation, networking, and print information through SyncThru™ Web Service . Your machine needs to be connected to a network. This button will be disabled if your machine is connected via USB cable.
6	Device List & Latest Scanned Image	The scan list displays devices that supports Samsung Printer Experience . Under the device, you can see the latest scanned images. Your machine needs to be connected to a network to scan from here. This section is for the users with multi-functional printers.

Adding/Deleting Printers

If you do not have any printer added to the **Samsung Printer Experience**, or if you want to add/delete a printer, follow the instructions below.



You can only add/delete network connected printers.

Adding a printer

- 1 From the **Charms**, select **Settings**.
Or, right-click the **Samsung Printer Experience** page and select **Settings**.
- 2 Select **Add Printer**
- 3 Select the printer you want to add.
You can see the added printer.



If you see  mark, you can also click  mark to add printers.

Using Samsung Printer Experience

Deleting a printer

- 1 From the **Charms**, select **Settings**.
Or, right-click the **Samsung Printer Experience** page and select **Settings**.
- 2 Select **Remove Printer**
- 3 Select the printer you want to delete.
- 4 Click **Yes**.
You can see that the deleted printer is removed from the screen.

Printing from Windows 8

This section explains common printing tasks from the **Start** screen.

Basic printing



- 1 Open the document to print.
- 2 From the **Charms**, select **Devices**.
- 3 Select your printer from the list

- 4 Select the printer settings, such as the number of copies and orientation.
- 5 Click the **Print** button to start the print job.



Cancelling a print job

If the printing job is waiting in the print queue or print spooler, cancel the job as follows:

- You can access this window by simply double-clicking the machine icon () in the Windows task bar.
- You can also cancel the current job by pressing  (**Cancel** or **Stop/Clear**) button on the control panel.

Using Samsung Printer Experience

Opening more settings



The screen may appear somewhat different depending on the model or options.

You can set up more printing parameters.

- 1 Open the document you want to print.
- 2 From the **Charms**, select **Devices**.
- 3 Select your printer from the list
- 4 Click **More settings**.

Basic tab



Basic

This option allows you to choose the basic printing settings such as copies, orientation, and document type.

Eco settings

This option allows you to choose multiple pages per side to save media.

Using Samsung Printer Experience

Advanced tab

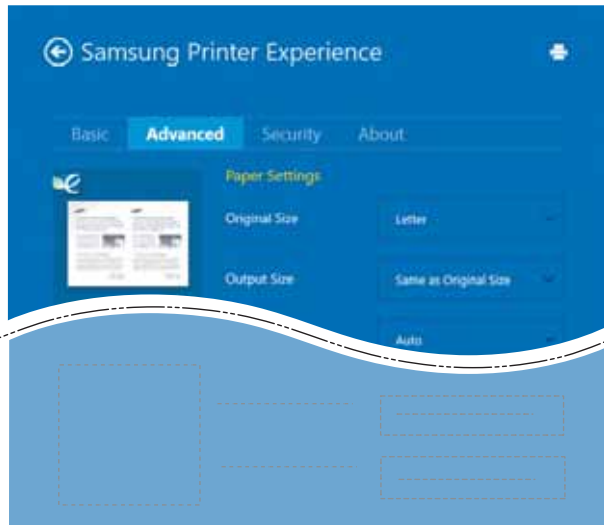

Paper settings

This option allows you to set the basic paper handling specifications.

Layout settings

This option allows you to set the various ways to layout your documents.

Security tab



Some features may not be available depending on the model or options. If this tab is not shown or disabled, it means that these features are not supported.

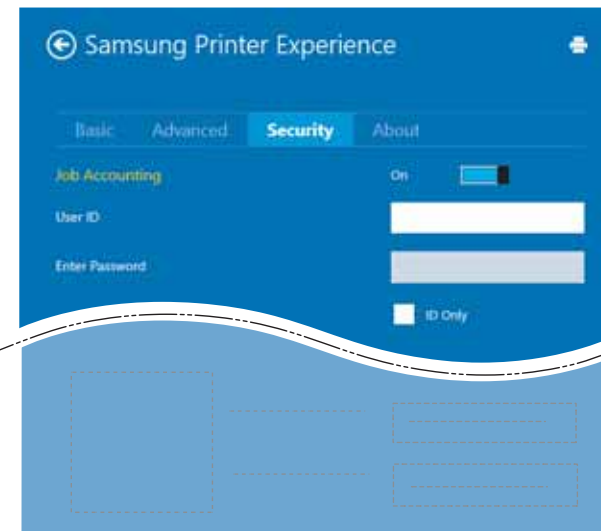

Job Accounting

This option allows you to print with the given permission.

Confidential Printing

This option is used for printing confidential documents. You need to enter a password to print using it.

Using Samsung Printer Experience

Using the sharing feature

Samsung Printer Experience allows you to print from other applications installed on the computer using the sharing feature.



This feature is only available for printing jpeg, bmp, tiff, gif, and png file formats.

- 1 Select the content you want to print from other application.
- 2 From the **Charms**, select **Share** > **Samsung Printer Experience** .
- 3 Select the printer settings, such as the number of copies and orientation.
- 4 Click the **Print** button to start the print job.



5. Troubleshooting

This chapter gives helpful information for what to do if you encounter an error.

- **Paper feeding problems** 175
- **Power and cable connecting problems** 176
- **Printing problems** 177
- **Printing quality problems** 181
- **Operating system problems** 189

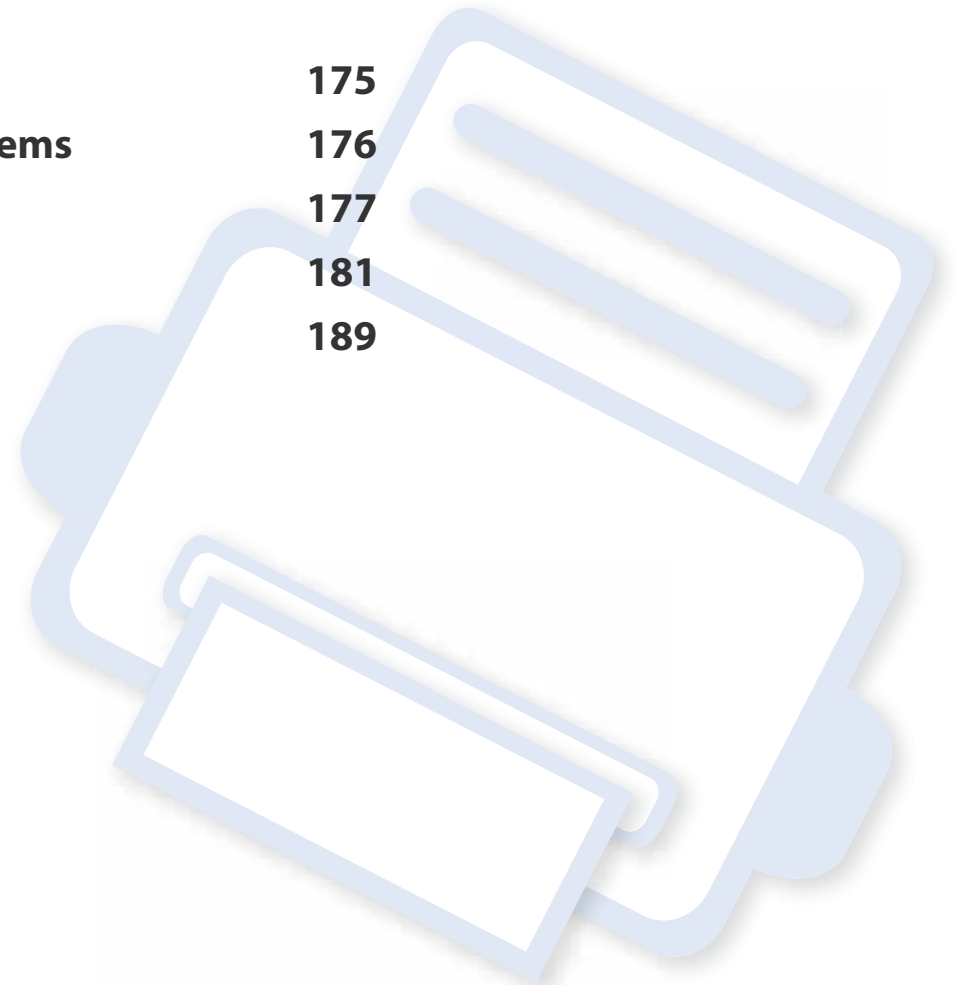

Paper feeding problems

Condition	Suggested solutions
Paper jams during printing.	Clear the paper jam.
Paper sticks together.	<ul style="list-style-type: none">• Check the maximum paper capacity of the tray.• Make sure that you are using the correct type of paper.• Remove paper from the tray and flex or fan the paper.• Humid conditions may cause some paper to stick together.
Multiple sheets of paper do not feed.	Different types of paper may be stacked in the tray. Load paper of only one type, size, and weight.
Paper does not feed into the machine.	<ul style="list-style-type: none">• Remove any obstructions from inside the machine.• Paper has not been loaded correctly. Remove paper from the tray and reload it correctly.• There is too much paper in the tray. Remove excess paper from the tray.• The paper is too thick. Use only paper that meets the specifications required by the machine.
The paper keeps jamming.	<ul style="list-style-type: none">• There is too much paper in the tray. Remove excess paper from the tray. If you are printing on special materials, feed manually in the tray.• An incorrect type of paper is being used. Use only paper that meets the specifications required by the machine.• There may be debris inside the machine. Open the top cover and remove any debris.

Power and cable connecting problems

Reboot the power. If the problem persists, please call for service.

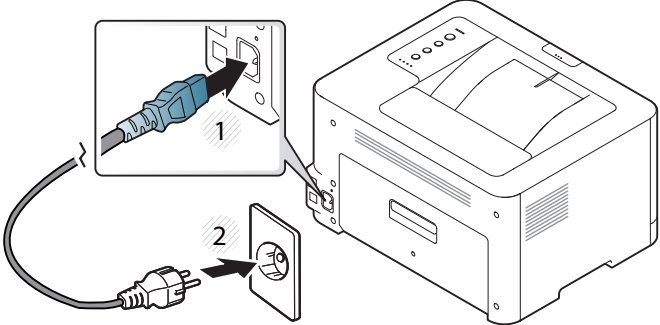
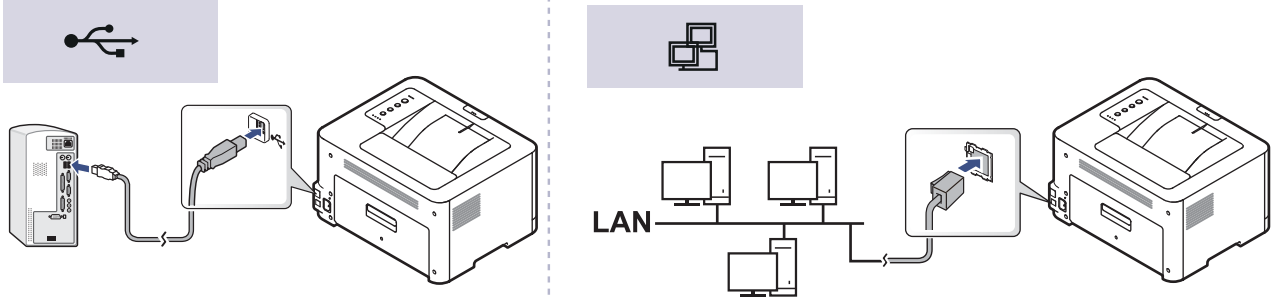
Condition	Suggested solutions
<p>The machine is not receiving power, or the connection cable between the computer and the machine is not connected properly.</p>	<p>1 Connect the machine to the electricity supply first.</p>  <p>2 Check the USB cable or network cable in the machine's rear.</p>  <p>3 Disconnect the USB cable or network cable in the machine's rear and then, reconnect it.</p>

Printing problems

Condition	Possible cause	Suggested solutions
The machine does not print.	The machine is not receiving power.	Check the power cord connections. Check the power switch and the power source.
	The machine is not selected as the default machine.	Select your machine as your default machine in Windows.
	Check the machine for the following: <ul style="list-style-type: none">• The top cover is not closed. Close the top cover.• Paper is jammed. Clear the paper jam (see "Clearing paper jams" on page 60).• No paper is loaded. Load paper (see "Loading paper in the tray" on page 29).• The toner cartridge is not installed. Install the toner cartridge (see "Replacing the toner cartridge" on page 49).• Make sure the protect cover and sheets are removed from the toner cartridge (see "Replacing the toner cartridge" on page 49). If a system error occurs, contact your service representative.	
	The connection cable between the computer and the machine is not connected properly.	Disconnect the machine cable and reconnect it (see "Rear view" on page 19).
	The connection cable between the computer and the machine is defective.	If possible, attach the cable to another computer that is working properly and print a job. You can also try using a different machine cable.
	The port setting is incorrect.	Check the Windows printer settings to make sure that the print job is sent to the correct port. If the computer has more than one port, make sure that the machine is attached to the correct one.
	The machine may be configured incorrectly.	Check the Printing Preferences to ensure that all of the print settings are correct.

Printing problems

Condition	Possible cause	Suggested solutions
The machine does not print.	The printer driver may be incorrectly installed.	Uninstall and reinstall the machine's driver.
	The machine is malfunctioning.	Check the display message on the control panel to see if the machine is indicating a system error. Contact a service representative.
	The document size is so big that the hard disk space of the computer is insufficient to access the print job.	Get more hard disk space and print the document again.
	The output tray is full.	Once the paper is removed from the output tray, the machine resumes printing.
The machine selects print materials from the wrong paper source.	The paper option that was selected in the Printing Preferences may be incorrect.	For many software applications, the paper source selection is found under the Paper tab within the Printing Preferences (see "Opening Printing Preferences" on page 37). Select the correct paper source. See the printer driver help screen (see "Using help" on page 39).
A print job is extremely slow.	The job may be very complex.	Reduce the complexity of the page or try adjusting the print quality settings.
Half the page is blank.	The page orientation setting may be incorrect.	Change the page orientation in your application (see "Opening Printing Preferences" on page 37). See the printer driver help screen (see "Using help" on page 39).
	The paper size and the paper size settings do not match.	Ensure that the paper size in the printer driver settings matches the paper in the tray. Or, ensure that the paper size in the printer driver settings matches the paper selection in the software application settings you use (see "Opening Printing Preferences" on page 37).

Printing problems

Condition	Possible cause	Suggested solutions
The machine prints, but the text is wrong, garbled, or incomplete.	The machine cable is loose or defective.	Disconnect the machine cable and reconnect. Try a print job that you have already printed successfully. If possible, attach the cable and the machine to another computer that you know works and try a print job. Finally, try a new machine cable.
	The wrong printer driver was selected.	Check the application's printer selection menu to ensure that your machine is selected.
	The software application is malfunctioning.	Try printing a job from another application.
	The operating system is malfunctioning.	Exit Windows and reboot the computer. Turn the machine off and back on again.
Pages print, but they are blank.	The toner cartridge is defective or out of toner.	Redistribute the toner, if necessary. If necessary, replace the toner cartridge. <ul style="list-style-type: none"> • See "Redistributing toner" on page 47. • See "Replacing the toner cartridge" on page 49.
	The file may have blank pages.	Check the file to ensure that it does not contain blank pages.
	Some parts, such as the controller or the board, may be defective.	Contact a service representative.
The machine does not print PDF files correctly. Some parts of graphics, text, or illustrations are missing.	Incompatibility between the PDF file and the Acrobat products.	Printing the PDF file as an image may enable the file to print. Turn on Print As Image from the Acrobat printing options. <div data-bbox="1081 1141 2190 1260" style="border: 1px solid #ccc; background-color: #f9f9f9; padding: 10px; margin-top: 10px;">  It will take longer to print when you print a PDF file as an image. </div>
The print quality of photos is not good. Images are not clear.	The resolution of the photo is very low.	Reduce the photo size. If you increase the photo size in the software application, the resolution will be reduced.

Printing problems

Condition	Possible cause	Suggested solutions
Before printing, the machine emits vapor near the output tray.	Using damp/wet paper can cause vapor [white smoke] during printing.	This is not a problem, just keep printing. If you are bothered by the smoke [vapor], then replace the paper with fresh paper from an unopened ream.
The machine does not print special-sized paper, such as billing paper.	Paper size and paper size setting do not match.	Set the correct paper size in the Custom in Paper tab in Printing Preferences (see "Opening Printing Preferences" on page 37).
The printed billing paper is curled.	The paper type setting does not match.	Change the printer option and try again. Go to Printing Preferences , click Paper tab, and set type to Thick (see "Opening Printing Preferences" on page 37).

Printing quality problems

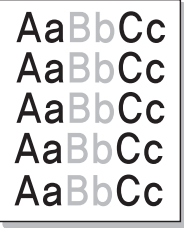
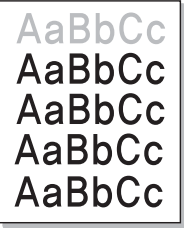

If the inside of the machine is dirty or paper has been loaded improperly, there might be a reduction in print quality. See the table below to clear the problem.

Condition	Suggested Solutions
<p data-bbox="51 359 322 389">Light or faded print</p> 	<ul data-bbox="506 359 2190 845" style="list-style-type: none">• If a vertical white streak or faded area appears on the page, the toner supply is low. Install a new toner cartridge (see "Replacing the toner cartridge" on page 49).• If a vertical white streak or faded area still appears on the page even though the machine has enough toner supply, open and close the front door 3 ~ 4 times (see "Machine overview" on page 17).• The paper may not meet paper specifications; for example, the paper may be too moist or rough.• If the entire page is light, the print resolution setting is too low or the toner save mode is on. Adjust the print resolution and turn the toner save mode off. See the help screen of the printer driver.• A combination of faded or smeared defects may indicate that the toner cartridge needs cleaning. Clean the inside of your machine (see "Cleaning the machine" on page 55).• The surface of the LSU part inside the machine may be dirty. Clean the inside of your machine (see "Cleaning the machine" on page 55). If these steps do not correct the problem, contact a service representative.
<p data-bbox="51 880 472 994">The top half of the paper is printed lighter than the rest of the paper</p> 	<p data-bbox="506 880 1249 911">The toner might not adhere properly to this type of paper.</p> <ul data-bbox="506 935 2190 1005" style="list-style-type: none">• Change the printer option and try again. Go to Printing Preferences, click the Paper tab, and set the paper type to Recycled (see "Opening Printing Preferences" on page 37).

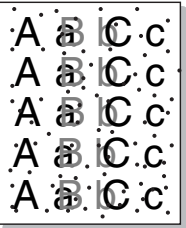
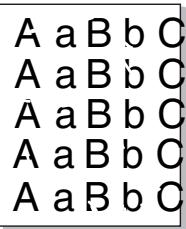
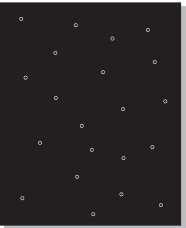
Printing quality problems

Condition	Suggested Solutions
<p>Toner specks</p> 	<ul style="list-style-type: none">• The paper may not meet specifications; for example, the paper may be too moist or rough.• The transfer roller may be dirty. Clean the inside of your machine (see "Cleaning the machine" on page 55).• The paper path may need cleaning. Contact a service representative (see "Cleaning the machine" on page 55).
<p>Dropouts</p> 	<p>If faded areas, generally rounded, occur randomly on the page:</p> <ul style="list-style-type: none">• A single sheet of paper may be defective. Try reprinting the job.• The moisture content of the paper is uneven or the paper has moist spots on its surface. Try a different brand of paper.• The paper lot is bad. The manufacturing processes can cause some areas to reject toner. Try a different kind or brand of paper.• Change the printer option and try again. Go to Printing Preferences, click the Paper tab, and set type to Thick or Thicker (see "Opening Printing Preferences" on page 37). <p>If these steps do not correct the problem, contact a service representative.</p>
<p>White Spots</p> 	<p>If white spots appear on the page:</p> <ul style="list-style-type: none">• The paper is too rough and a lot of dirt from paper falls to the inner components within the machine, so the transfer roller may be dirty. Clean the inside of your machine (see "Cleaning the machine" on page 55).• The paper path may need cleaning. Clean the inside of your machine (see "Cleaning the machine" on page 55). <p>If these steps do not correct the problem, contact a service representative.</p>

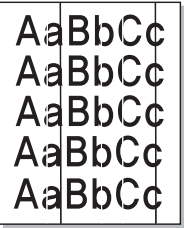
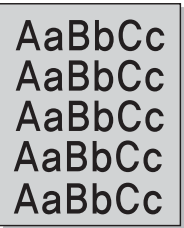
Printing quality problems

Condition	Suggested Solutions
<p>Vertical lines</p> 	<p>If black vertical streaks appear on the page:</p> <ul style="list-style-type: none">• The surface (drum part) of the imaging unit inside the machine has probably been scratched. Remove the toner cartridge and install a new one (see "Replacing the imaging unit" on page 53). <p>If white vertical streaks appear on the page:</p> <ul style="list-style-type: none">• The surface of the LSU part inside the machine may be dirty. Clean the inside of your machine (see "Cleaning the machine" on page 55). If these steps do not correct the problem, contact a service representative.
<p>Black background</p> 	<p>If the amount of background shading becomes unacceptable:</p> <ul style="list-style-type: none">• Change to a lighter weight paper.• Check the environmental conditions: very dry conditions or a high level of humidity (higher than 80% RH) can increase the amount of background shading.• Remove the old imaging unit and install a new one (see "Replacing the imaging unit" on page 53).• Thoroughly redistribute the toner (see "Redistributing toner" on page 47).
<p>Toner smear</p> 	<ul style="list-style-type: none">• Clean the inside of the machine (see "Replacing the toner cartridge" on page 49).• Check the paper type and quality.• Remove the old imaging unit and install a new one (see "Replacing the imaging unit" on page 53).

Printing quality problems

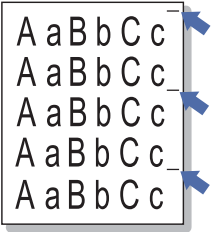
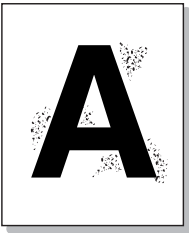
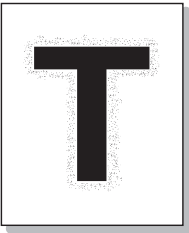
Condition	Suggested Solutions
<p data-bbox="49 272 407 304">Vertical repetitive defects</p> 	<p data-bbox="504 272 1473 304">If marks repeatedly appear on the printed side of the page at even intervals:</p> <ul data-bbox="504 328 2190 544" style="list-style-type: none"><li data-bbox="504 328 2190 400">• The imaging unit may be damaged. If you still have the same problem, remove the imaging unit and, install a new one (see "Replacing the imaging unit" on page 53).<li data-bbox="504 416 2190 488">• Parts of the machine may have toner on them. If the defects occur on the back of the page, the problem will likely correct itself after a few more pages.<li data-bbox="504 504 1464 544">• The fusing assembly may be damaged. Contact a service representative.
<p data-bbox="49 612 322 644">Background scatter</p> 	<p data-bbox="504 612 1621 644">Background scatter results from bits of toner randomly distributed on the printed page.</p> <ul data-bbox="504 668 2190 927" style="list-style-type: none"><li data-bbox="504 668 2190 740">• The paper may be too damp. Try printing with a different batch of paper. Do not open packages of paper until necessary so that the paper does not absorb too much moisture.<li data-bbox="504 756 2190 876">• If background scatter covers the entire surface area of a printed page, adjust the print resolution through your software application or in Printing Preferences (see "Opening Printing Preferences" on page 37). Ensure the correct paper type is selected. For example: If Thicker Paper is selected, but Plain Paper actually used, an overcharging can occur causing this copy quality problem.<li data-bbox="504 892 1872 927">• If you are using a new toner cartridge, redistribute the toner first (see "Redistributing toner" on page 47).
<p data-bbox="49 959 479 1031">Toner particles are around bold characters or pictures</p> 	<p data-bbox="504 959 1249 991">The toner might not adhere properly to this type of paper.</p> <ul data-bbox="504 1015 2190 1174" style="list-style-type: none"><li data-bbox="504 1015 2190 1086">• Change the printer option and try again. Go to Printing Preferences, click the Paper tab, and set the paper type to Recycled (see "Opening Printing Preferences" on page 37).<li data-bbox="504 1102 2190 1174">• Ensure the correct paper type is selected. For example: If Thicker Paper is selected, but Plain Paper actually used, an overcharging can occur causing this copy quality problem.

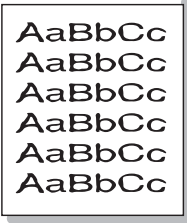
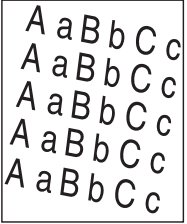
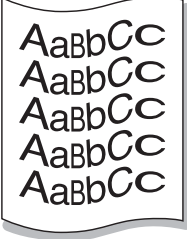

Printing quality problems

Condition	Suggested Solutions
<p data-bbox="49 272 353 304">Misformed characters</p> 	<ul data-bbox="504 272 2072 304" style="list-style-type: none">• If characters are improperly formed and producing hollow images, the paper stock may be too slick. Try different paper.
<p data-bbox="49 608 203 639">Page skew</p> 	<ul data-bbox="504 608 1518 743" style="list-style-type: none">• Ensure that the paper is loaded properly.• Check the paper type and quality.• Ensure that the guides are not too tight or too loose against the paper stack.
<p data-bbox="49 951 230 983">Curl or wave</p> 	<ul data-bbox="504 951 1729 1086" style="list-style-type: none">• Ensure that the paper is loaded properly.• Check the paper type and quality. Both high temperature and humidity can cause paper curl.• Turn the stack of paper over in the tray. Also try rotating the paper 180° in the tray.

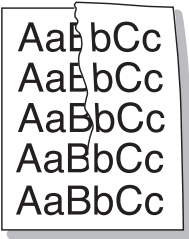
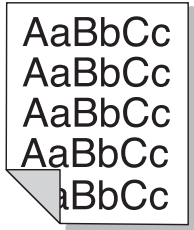
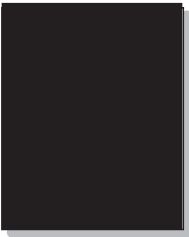
Printing quality problems

Condition	Suggested Solutions
<p data-bbox="49 272 318 304">Wrinkles or creases</p> 	<ul data-bbox="504 272 1599 411" style="list-style-type: none">• Ensure that the paper is loaded properly.• Check the paper type and quality.• Turn the stack of paper over in the tray. Also try rotating the paper 180° in the tray.
<p data-bbox="49 619 412 651">Back of printouts are dirty</p> 	<ul data-bbox="504 619 1787 651" style="list-style-type: none">• Check for leaking toner. Clean the inside of the machine (see "Cleaning the machine" on page 55).
<p data-bbox="49 986 405 1018">Solid color or black pages</p> 	<ul data-bbox="504 986 2197 1125" style="list-style-type: none">• The imaging unit may not be installed properly. Remove the imaging unit and reinsert it.• The imaging unit may be defective. Remove the imaging unit and install a new one (see "Replacing the imaging unit" on page 53).• The machine may require repairing. Contact a service representative.

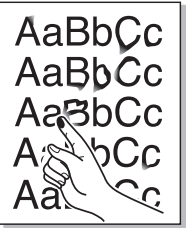
Printing quality problems

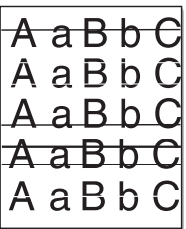
Condition	Suggested Solutions
<p>Loose toner</p> 	<ul style="list-style-type: none">• Clean the inside of the machine (see "Cleaning the machine" on page 55).• Check the paper type and quality.• Remove the imaging unit and then, install a new one (see "Replacing the imaging unit" on page 53). <p>If the problem persists, the machine may require repair. Contact a service representative.</p>
<p>Character voids</p> 	<p>Character voids are white areas within parts of characters that should be solid black:</p> <ul style="list-style-type: none">• You may be printing on the wrong surface of the paper. Remove the paper and turn it around.• The paper may not meet paper specifications.
<p>Horizontal stripes</p> 	<p>If horizontally aligned black streaks or smears appear:</p> <ul style="list-style-type: none">• The imaging unit may be installed improperly. Remove the imaging unit and reinsert it.• The imaging unit may be defective. Remove the imaging unit and install a new one (see "Replacing the imaging unit" on page 53). <p>If the problem persists, the machine may require repairing. Contact a service representative.</p>

Printing quality problems

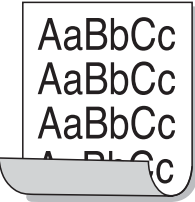
Condition	Suggested Solutions
<p>Curl</p> 	<p>If the printed paper is curled or paper does not feed into the machine:</p> <ul style="list-style-type: none">• Turn the stack of paper over in the tray. Also try rotating the paper 180° in the tray.• Change the printer's paper option and try again. Go to Printing Preferences, click the Paper tab, and set type to Thin (see "Opening Printing Preferences" on page 37).
<ul style="list-style-type: none">• An unknown image repetitively appears on a few sheets• Loose toner• Light print or contamination occurs	<p>Your machine is probably being used at an altitude of 1,000 m (3,281 ft) or above.</p> <p>The high altitude may affect the print quality, such as loose toner or light imaging. Change the altitude setting for your machine (See "Altitude adjustment" on page 140).</p>

Operating system problems

Common Windows problems

Condition	Suggested solutions
“File in Use” message appears during installation.	Exit all software applications. Remove all software from the startup group, then restart Windows. Reinstall the printer driver.
“General Protection Fault”, “Exception OE”, “Spool 32”, or “Illegal Operation” messages appear.	Close all other applications, reboot Windows and try printing again.
“Fail To Print”, “A printer timeout error occurred” message appear.	These messages may appear during printing. Just keep waiting until the machine finishes printing. If the message appears in ready mode or after printing has completed, check the connection and/or whether an error has occurred.
Samsung Printer Experience is not shown when you click more settings .	Samsung Printer Experience is not installed. Download the app. from the Windows Store and install it.
Machine information is not displayed when you click the device in the Devices and Printers .	Check the Printer properties . Click the Ports tab. (Control Panel > Devices and Printers > Right-click on your printer icon and select Printer properties) If the port is set to File or LPT, uncheck them and select TCP/IP, USB, or WSD.



Refer to the Microsoft Windows User’s Guide that came with your computer for further information on Windows error messages.

Operating system problems

Common Mac problems

Condition	Suggested solutions
The machine does not print PDF files correctly. Some parts of graphics, text, or illustrations are missing.	<p>Printing the PDF file as an image may enable the file to print. Turn on Print As Image from the Acrobat printing options.</p> <p> It will take longer to print when you print a PDF file as an image.</p>
Some letters are not displayed normally during cover page printing.	<p>Mac OS cannot create the font while printing the cover page. The English alphabet and numbers are displayed normally on the cover page.</p>
When printing a document in Mac with Acrobat Reader 6.0 or higher, colors print incorrectly.	<p>Make sure that the resolution setting in your machine driver matches the one in Acrobat Reader.</p>



Refer to the Mac User's Guide that came with your computer for further information on Mac error messages.

Operating system problems

Common Linux problems

Condition	Suggested solutions
Unchecking the collate option in the Print Dialog does not work.	For some distributions, GNOME Print Dialog has an issue handling the collate option. As workaround, set the default value of collate option to False using the system's printing utility(execute "system-config-printer" in the Terminal program).
Printing always works with duplex.	This duplex issue was in Ubuntu 9.10 CUPS package. Update CUPS version to 1.4.1-5ubuntu2.2.
Printer is not added through system's printing utility.	The problem occurs on Debian 7 due to the defect in 'system-config-printer' package of the Debian 7 (http://bugs.debian.org/cgi-bin/bugreport.cgi?bug=662813 in Debian bug tracking system). Please use another way to add printer (CUPS WebUI for example)
Paper size and orientation are disabled in the Print Dialog when opening text files.	The problem occurs on Fedora 19 and it's related to 'leafpad' text editor on Fedora 19. Please use other text editors like 'gedit'.
Printing produces divided images.	This issue exists in openSUSE 13.2 due to wrong ghostscript provided by the system. Update 'cups-filters-ghostscript' package with the command "zypper install --force cups-filters-ghostscript" or with "Install/Remove Software" utility.



Refer to the Linux User's Guide that came with your computer for further information on Linux error messages.

Contact SAMSUNG worldwide

If you have any comments or questions regarding Samsung products, contact the Samsung customer care center.

Country/Region	Customer Care Center	WebSite
ALGERIA	3004 (Toll Free)	www.samsung.com/n_africa/support
ANGOLA	917 267 864	www.samsung.com/support
ARGENTINE	0800-555-SAM(7267)	www.samsung.com/ar
ARMENIA	0-800-05-555	www.samsung.com/support
AUSTRALIA	1300 362 603	www.samsung.com/au/support
AUSTRIA	0800-SAMSUNG (0800-7267864) [Only for Premium HA] 0800-366661 [Only for Dealers] 0810-112233	www.samsung.com/at/support
AZERBAIJAN	0-88-555-55-55	www.samsung.com/support
BAHRAIN	8000-GSAM (8000-4726)	www.samsung.com/ae/support (English) www.samsung.com/ae_ar/support (Arabic)
BANGLADESH	0961-2300300 0800-0300300 (Toll free)	www.samsung.com/in/support

Country/Region	Customer Care Center	WebSite
BELARUS	810-800-500-55-500	www.samsung.com/support
BELGIUM	02-201-24-18	www.samsung.com/be/support (Dutch) www.samsung.com/be_fr/support (French)
BOLIVIA	800-10-7260	www.samsung.com/cl/support
BOSNIA	055 233 999	www.samsung.com/support
BOTSWANA	8007260000	www.samsung.com/support
BRAZIL	0800-124-421 (Demais cidades e regiões) 4004-0000 (Capitais e grandes centros)	www.samsung.com/br/support
BULGARIA	0800 111 31 , Безплатна телефонна линия	www.samsung.com/bg/support
BURUNDI	200	www.samsung.com/support
CAMEROON	7095- 0077	www.samsung.com/africa_fr/support
CANADA	1-800-SAMSUNG (726-7864)	www.samsung.com/ca/support(English) www.samsung.com/ca_fr/support (French)

Contact SAMSUNG worldwide

Country/Region	Customer Care Center	WebSite
CHILE	800-SAMSUNG (726-7864) [HHP] 02-24828200	www.samsung.com/ cl/support
CHINA	400-810-5858	www.samsung.com/ cn/support
COLOMBIA	Bogotá en el 600 12 72 Sin costo en todo el país 01 8000 112 112 Y desde tu celular #726	www.samsung.com/ co
COSTA RICA	00-800-1-SAMSUNG (726-7864)	www.samsung.com/ latin/support (Spanish) www.samsung.com/ latin_en/support (English)
CROATIA	072 726 786	www.samsung.com/ hr/support
Cote D' Ivoire	8000 0077	www.samsung.com/ africa_fr/support
CYPRUS	8009 4000 only from landline, toll free	www.samsung.com/ gr/support
CZECH	800-SAMSUNG (800-726786)	www.samsung.com/ cz/support
DENMARK	70 70 19 70	www.samsung.com/ dk/support

Country/Region	Customer Care Center	WebSite
DOMINICAN REPUBLIC	1-800-751-2676	www.samsung.com/ latin/support (Spanish) www.samsung.com/ latin_en/support (English)
DRC	4999999	www.samsung.com/ support
ECUADOR	1-800-SAMSUNG (72-6786)	www.samsung.com/ latin/support (Spanish) www.samsung.com/ latin_en/ support(English)
EGYPT	08000-7267864 16580	www.samsung.com/ eg/support
EIRE	0818 717100	www.samsung.com/ ie/support
EL SALVADOR	8000-SAMSUNG (726-7864)	www.samsung.com/ latin/support (Spanish) www.samsung.com/ latin_en/support (English)
ESTONIA	800-7267	www.samsung.com/ ee/support

Contact SAMSUNG worldwide

Country/Region	Customer Care Center	WebSite
FINLAND	030-6227 515	www.samsung.com/fi/support
FRANCE	01 48 63 00 00	www.samsung.com/fr/support
GERMANY	0180 6 SAMSUNG bzw. 0180 6 7267864* (*0,20 €/Anruf aus dem dt. Festnetz, aus dem Mobilfunk max. 0,60 €/Anruf) [HHP] 0180 6 M SAMSUNG bzw. 0180 6 67267864* (*0,20 €/Anruf aus dem dt. Festnetz, aus dem Mobilfunk max. 0,60 €/Anruf)	www.samsung.com/de/support
GEORGIA	0-800-555-555	www.samsung.com/support
GHANA	0800-10077 0302-200077	www.samsung.com/africa_en/support
GREECE	80111-SAMSUNG (80111 726 7864) only from land line (+30) 210 6897691 from mobile and land line	www.samsung.com/gr/support

Country/Region	Customer Care Center	WebSite
GUATEMALA	1-800-299-0033	www.samsung.com/latin/support (Spanish) www.samsung.com/latin_en/support (English)
HONDURAS	800-2791-9111	www.samsung.com/latin/support (Spanish) www.samsung.com/latin_en/support (English)
HONG KONG	3698 4698	www.samsung.com/hk/support (Chinese) www.samsung.com/hk_en/support (English)
HUNGARY	0680SAMSUNG (0680-726-786) 0680PREMIUM (0680-773-648)	www.samsung.com/hu/support
INDIA	1800 3000 8282 - Toll Free 1800 266 8282 - Toll Free	www.samsung.com/in/support
INDONESIA	021-56997777 08001128888	www.samsung.com/id/support
IRAN	021-8255 [CE] 021-42132 [HHP]	www.samsung.com/iran/support

Contact SAMSUNG worldwide

Country/Region	Customer Care Center	WebSite
ITALIA	800-SAMSUNG (800.7267864)	www.samsung.com/ it/support
JAMAICA	1-800-SAMSUNG (726-7864)	www.samsung.com/ latin_en/support (English)
JAPAN	0120-363-905	www.samsung.com/ jp/support
JORDAN	0800-22273 06 5777444	www.samsung.com/ Levant
KAZAKHSTAN	8-10-800-500-55-500 (GSM: 7799, VIP care 7700)	www.samsung.com/ kz_ru/support
KENYA	0800 545 545	www.samsung.com/ support
KUWAIT	183-CALL (183-2255)	www.samsung.com/ ae/support (English) www.samsung.com/ ae_ar/support (Arabic)
KYRGYZSTAN	00-800-500-55-500 (GSM: 9977)	www.samsung.com/ support
LATVIA	8000-7267	www.samsung.com/ lv/support
LEBANON	961 1484 999	www.samsung.com/ Levant
LITHUANIA	8-800-77777	www.samsung.com/ lt/support

Country/Region	Customer Care Center	WebSite
LUXEMBURG	261 03 710	www.samsung.com/ be_fr/support
MACAU	0800 333	www.samsung.com/ support
MACEDONIA	023 207 777	
MALAYSIA	1800-88-9999 603-77137477 (Overseas contact)	www.samsung.com/ my/support
MAURITIUS	800 2550	www.samsung.com/ support
MEXICO	01-800-SAMSUNG (726-7864)	www.samsung.com/ mx/support
MOLDOVA	0-800-614-40	www.samsung.com/ support
MONGOLIA	+7-495-363-17-00	www.samsung.com/ support
MONTENEGRO	020 405 888	www.samsung.com/ support
MOROCCO	080 100 22 55	www.samsung.com/ n_africa/support
MOZAMBIQUE	847267864 / 827267864	www.samsung.com/ support
MYANMAR	+95-01-2399-888	www.samsung.com/ support
NAMIBIA	08 197 267 864	www.samsung.com/ support

Contact SAMSUNG worldwide

Country/Region	Customer Care Center	WebSite
NIGERIA	0800-726-7864	www.samsung.com/ africa_en/support
NETHERLANDS	0900-SAMSUNG (0900-7267864) (€ 0,10/Min)	www.samsung.com/ nl/support
NEW ZEALAND	0800 726 786	www.samsung.com/ nz/support
NICARAGUA	001-800-5077267	www.samsung.com/ latin/support(Spanish) www.samsung.com/ latin_en/support (English)
NORWAY	815 56480	www.samsung.com/ no/support
OMAN	800-SAMSUNG (800 - 726 7864)	www.samsung.com/ ae/support (English) www.samsung.com/ ae_ar/support (Arabic)
PAKISTAN	0800-Samsung (72678)	www.samsung.com/ pk/support
PANAMA	800-0101	www.samsung.com/ latin/support (Spanish) www.samsung.com/ latin_en/support (English)
PARAGUAY	0800-11-SAMS(7267)	www.samsung.com/ar

Country/Region	Customer Care Center	WebSite
PERU	0800-777-08	www.samsung.com/ pe/support
PHILIPPINES	1-800-10-726-7864 [PLDT Toll Free] 1-800-8-726-7864 [Globe Landline and Mobile] 02- 422-2111 [Standard Landline]	www.samsung.com/ ph/support
POLAND	801-172-678* lub +48 22 607-93- 33* Dedykowana infolinia do obsługi zapytań dotyczących telefonów komórkowych: 801-672-678* lub +48 22 607-93-33* * (koszt połączenia według taryfy operatora)	www.samsung.com/ pl/support
PORTUGAL	808 20 7267	www.samsung.com/ pt/support
PUERTO RICO	1-800-682-3180	www.samsung.com/ latin/support (Spanish) www.samsung.com/ latin_en/support (English)

Contact SAMSUNG worldwide

Country/Region	Customer Care Center	WebSite
QATAR	800-CALL (800-2255)	www.samsung.com/ ae/support (English) www.samsung.com/ ae_ar/support (Arabic)
REUNION	0262 50 88 80	www.samsung.com/ support
RWANDA	9999	www.samsung.com/ support
ROMANIA	*8000 (apel in retea) 08008-726-78-64 (08008- SAMSUNG) Apel GRATUIT	www.samsung.com/ ro/support
RUSSIA	8-800-555-55-55 (VIP care 8-800- 555-55-88)	www.samsung.com/ ru/support
SAUDI ARABIA	800 247 3457 (800 24/7 HELP)	www.samsung.com/ sa/home www.samsung.com/ sa_en
SENEGAL	800-00-0077	www.samsung.com/ africa_fr/support
SERBIA	011 321 6899	www.samsung.com/ rs/support
SINGAPORE	1800-SAMSUNG (726-7864)	www.samsung.com/ sg/support
SLOVENIA	080 697 267 (brezplačna številka)	www.samsung.com/si

Country/Region	Customer Care Center	WebSite
SLOVAKIA	0800 - SAMSUNG (0800-726 786)	www.samsung.com/ sk/support
SOUTH AFRICA	0860 SAMSUNG (726 7864)	www.samsung.com/ support
SPAIN	0034902172678 [HHP] 0034902167267	www.samsung.com/ es/support
SRI LANKA	0117540540 0115900000	www.samsung.com/ support
SUDAN	1969	www.samsung.com/ support
SWEDEN	0771 726 7864 (0771-SAMSUNG)	www.samsung.com/ se/support
SWITZERLAND	0800 726 78 64 (0800-SAMSUNG)	www.samsung.com/ ch/support (German) www.samsung.com/ ch_fr/support (French)
SYRIA	18252273	www.samsung.com/ Levant
TAJIKISTAN	8-10-800-500-55-500	www.samsung.com/ support
TAIWAN	0800-329999	www.samsung.com/ tw/support
TANZANIA	0800 755 755 0685 889 900	www.samsung.com/ support

Contact SAMSUNG worldwide

Country/Region	Customer Care Center	WebSite
THAILAND	0-2689-3232, 1800-29-3232	www.samsung.com/ th/support
TRINIDAD & TOBAGO	1-800-SAMSUNG (726-7864)	www.samsung.com/ latin/support (Spanish) www.samsung.com/ latin_en/support (English)
TURKEY	444 77 11	www.samsung.com/ tr/support
TUNISIA	80-1000-12	www.samsung.com/ n_africa/support
U.A.E	800-SAMSUNG (800 -726 7864)	www.samsung.com/ ae/support (English) www.samsung.com/ ae_ar/support (Arabic)
UK	0330 SAMSUNG (7267864)	www.samsung.com/ uk/support
U.S.A -Consumer Electronics	1-800-SAMSUNG (726-7864)	www.samsung.com/ us/support
U.S.A -(Mobile Phones)	1-800-SAMSUNG (726-7864)	www.samsung.com/ us/support
UGANDA	0800 300 300	www.samsung.com/ support

Country/Region	Customer Care Center	WebSite
UKRAINE	0-800-502-000	www.samsung.com/ ua/support (Ukrainian) www.samsung.com/ ua_ru/support (Russian)
URUGUAY	0800-SAMS(7267)	www.samsung.com/ar
UZBEKISTAN	00-800-500-55-500 (GSM: 7799)	www.samsung.com/ support
VENEZUELA	0-800-SAMSUNG (726-7864)	www.samsung.com/ ve/support
VIETNAM	1800 588 889	www.samsung.com/ vn/support
ZAMBIA	0211 350370	www.samsung.com/ support



The following glossary helps you get familiar with the product by understanding the terminologies commonly used with printing as well as mentioned in this user's guide.

802.11

802.11 is a set of standards for wireless local area network (WLAN) communication, developed by the IEEE LAN/MAN Standards Committee (IEEE 802).

802.11b/g/n

802.11b/g/n can share same hardware and use the 2.4 GHz band. 802.11b supports bandwidth up to 11 Mbps, 802.11n supports bandwidth up to 150 Mbps. 802.11b/g/n devices may occasionally suffer interference from microwave ovens, cordless telephones, and Bluetooth devices.

Access point

Access Point or Wireless Access Point (AP or WAP) is a device that connects wireless communication devices together on wireless local area networks (WLAN), and acts as a central transmitter and receiver of WLAN radio signals.

ADF

An Automatic Document Feeder (ADF) is a scanning unit that will automatically feed an original sheet of paper so that the machine can scan some amount of the paper at once.

AppleTalk

AppleTalk is a proprietary suite of protocols developed by Apple, Inc for computer networking. It was included in the original Mac (1984) and is now deprecated by Apple in favor of TCP/IP networking.

BIT Depth

A computer graphics term describing the number of bits used to represent the color of a single pixel in a bitmapped image. Higher color depth gives a broader range of distinct colors. As the number of bits increases, the number of possible colors becomes impractically large for a color map. 1-bit color is commonly called as monochrome or black and white.

BMP

A bitmapped graphics format used internally by the Microsoft Windows graphics subsystem (GDI), and used commonly as a simple graphics file format on that platform.

BOOTP

Bootstrap Protocol. A network protocol used by a network client to obtain its IP address automatically. This is usually done in the bootstrap process of computers or operating systems running on them. The BOOTP servers assign the IP address from a pool of addresses to each client. BOOTP enables 'diskless workstation' computers to obtain an IP address prior to loading any advanced operating system.

CCD

Charge Coupled Device (CCD) is a hardware which enables the scan job. CCD Locking mechanism is also used to hold the CCD module to prevent any damage when you move the machine.

Collation

Collation is a process of printing a multiple-copy job in sets. When collation is selected, the device prints an entire set before printing additional copies.

Control Panel

A control panel is a flat, typically vertical, area where control or monitoring instruments are displayed. They are typically found in front of the machine.

Coverage

It is the printing term used for a toner usage measurement on printing. For example, 5% coverage means that an A4 sided paper has about 5% image or text on it. So, if the paper or original has complicated images or lots of text on it, the coverage will be higher and at the same time, a toner usage will be as much as the coverage.

CSV

Comma Separated Values (CSV). A type of file format, CSV is used to exchange data between disparate applications. The file format, as it is used in Microsoft Excel, has become a de facto standard throughout the industry, even among non-Microsoft platforms.

DADF

A Duplex Automatic Document Feeder (DADF) is a scanning unit that will automatically feed and turn over an original sheet of paper so that the machine can scan on both sides of the paper.

Default

The value or setting that is in effect when taking a printer out of its box state, reset, or initialized.

DHCP

A Dynamic Host Configuration Protocol (DHCP) is a client-server networking protocol. A DHCP server provides configuration parameters specific to the DHCP client host requesting, generally, information required by the client host to participate on an IP network. DHCP also provides a mechanism for allocation of IP addresses to client hosts.

DIMM

Dual Inline Memory Module (DIMM), a small circuit board that holds memory. DIMM stores all the data within the machine like printing data, received fax data.

DLNA

The Digital Living Network Alliance (DLNA) is a standard that allows devices on a home network to share information with each other across the network.

DNS

The Domain Name Server (DNS) is a system that stores information associated with domain names in a distributed database on networks, such as the Internet.

Dot Matrix Printer

A dot matrix printer refers to a type of computer printer with a print head that runs back and forth on the page and prints by impact, striking an ink-soaked cloth ribbon against the paper, much like a typewriter.

DPI

Dots Per Inch (DPI) is a measurement of resolution that is used for scanning and printing. Generally, higher DPI results in a higher resolution, more visible detail in the image, and a larger file size.

DRPD

Distinctive Ring Pattern Detection. Distinctive Ring is a telephone company service which enables a user to use a single telephone line to answer several different telephone numbers.

Duplex

A mechanism that will automatically turn over a sheet of paper so that the machine can print (or scan) on both sides of the paper. A printer equipped with a Duplex Unit can print on both sides of paper during one print cycle.

Duty Cycle

Duty cycle is the page quantity which does not affect printer performance for a month. Generally the printer has the lifespan limitation such as pages per year. The lifespan means the average capacity of print-outs, usually within the warranty period. For example, if the duty cycle is 48,000 pages per month assuming 20 working days, a printer limits 2,400 pages a day.

ECM

Error Correction Mode (ECM) is an optional transmission mode built into Class 1 fax machines or fax modems. It automatically detects and corrects errors in the fax transmission process that are sometimes caused by telephone line noise.

Emulation

Emulation is a technique of one machine obtaining the same results as another.

An emulator duplicates the functions of one system with a different system, so that the second system behaves like the first system. Emulation focuses on exact reproduction of external behavior, which is in contrast to simulation, which concerns an abstract model of the system being simulated, often considering its internal state.

Ethernet

Ethernet is a frame-based computer networking technology for local area networks (LANs). It defines wiring and signaling for the physical layer, and frame formats and protocols for the media access control (MAC)/data link layer of the OSI model. Ethernet is mostly standardized as IEEE 802.3. It has become the most widespread LAN technology in use during the 1990s to the present.

EtherTalk

A suite of protocols developed by Apple Computer for computer networking. It was included in the original Mac (1984) and is now deprecated by Apple in favor of TCP/IP networking.

FDI

Foreign Device Interface (FDI) is a card installed inside the machine to allow a third party device such as a coin operated device or a card reader. Those devices allow the pay-for-print service on your machine.

FTP

A File Transfer Protocol (FTP) is a commonly used protocol for exchanging files over any network that supports the TCP/IP protocol (such as the Internet or an intranet).

Fuser Unit

The part of a laser printer that fuses the toner onto the print media. It consists of a heat roller and a pressure roller. After toner is transferred onto the paper, the fuser unit applies heat and pressure to ensure that the toner stays on the paper permanently, which is why paper is warm when it comes out of a laser printer.

Gateway

A connection between computer networks, or between a computer network and a telephone line. It is very popular, as it is a computer or a network that allows access to another computer or network.

Grayscale

A shades of gray that represents light and dark portions of an image when color images are converted to grayscale; colors are represented by various shades of gray.

Halftone

An image type that simulates grayscale by varying the number of dots. Highly colored areas consist of a large number of dots, while lighter areas consist of a smaller number of dots.

HDD

Hard Disk Drive (HDD), commonly referred to as a hard drive or hard disk, is a non-volatile storage device which stores digitally-encoded data on rapidly rotating platters with magnetic surfaces.

IEEE

The Institute of Electrical and Electronics Engineers (IEEE) is an international non-profit, professional organization for the advancement of technology related to electricity.

IEEE 1284

The 1284 parallel port standard was developed by the Institute of Electrical and Electronics Engineers (IEEE). The term "1284-B" refers to a specific connector type on the end of the parallel cable that attaches to the peripheral (for example, a printer).

Intranet

A private network that uses Internet Protocols, network connectivity, and possibly the public telecommunication system to securely share part of an organization's information or operations with its employees. Sometimes the term refers only to the most visible service, the internal website.

IP address

An Internet Protocol (IP) address is a unique number that devices use in order to identify and communicate with each other on a network utilizing the Internet Protocol standard.

IPM

The Images Per Minute (IPM) is a way of measuring the speed of a printer. An IPM rate indicates the number of single-sided sheets a printer can complete within one minute.

IPP

The Internet Printing Protocol (IPP) defines a standard protocol for printing as well as managing print jobs, media size, resolution, and so forth. IPP can be used locally or over the Internet to hundreds of printers, and also supports access control, authentication, and encryption, making it a much more capable and secure printing solution than older ones.

IPX/SPX

IPX/SPX stands for Internet Packet Exchange/Sequenced Packet Exchange. It is a networking protocol used by the Novell NetWare operating systems. IPX and SPX both provide connection services similar to TCP/IP, with the IPX protocol having similarities to IP, and SPX having similarities to TCP. IPX/SPX was primarily designed for local area networks (LANs), and is a very efficient protocol for this purpose (typically its performance exceeds that of TCP/IP on a LAN).

ISO

The International Organization for Standardization (ISO) is an international standard-setting body composed of representatives from national standards bodies. It produces world-wide industrial and commercial standards.

ITU-T

The International Telecommunication Union is an international organization established to standardize and regulate international radio and telecommunications. Its main tasks include standardization, allocation of the radio spectrum, and organizing interconnection arrangements between different countries to allow international phone calls. A -T out of ITU-T indicates telecommunication.

ITU-T No. 1 chart

Standardized test chart published by ITU-T for document facsimile transmissions.

JBIG

Joint Bi-level Image Experts Group (JBIG) is an image compression standard with no loss of accuracy or quality, which was designed for compression of binary images, particularly for faxes, but can also be used on other images.

JPEG

Joint Photographic Experts Group (JPEG) is a most commonly used standard method of lossy compression for photographic images. It is the format used for storing and transmitting photographs on the World Wide Web.

LDAP

The Lightweight Directory Access Protocol (LDAP) is a networking protocol for querying and modifying directory services running over TCP/IP.

LED

A Light-Emitting Diode (LED) is a semiconductor device that indicates the status of a machine.

MAC address

Media Access Control (MAC) address is a unique identifier associated with a network adapter. MAC address is a unique 48-bit identifier usually written as 12 hexadecimal characters grouped in pairs (e. g., 00-00-0c-34-11-4e). This address is usually hard-coded into a Network Interface Card (NIC) by its manufacturer, and used as an aid for routers trying to locate machines on large networks.

MFP

Multi Function Peripheral (MFP) is an office machine that includes the following functionality in one physical body, so as to have a printer, a copier, a fax, a scanner and etc.

MH

Modified Huffman (MH) is a compression method for decreasing the amount of data that needs to be transmitted between the fax machines to transfer the image recommended by ITU-T T.4. MH is a codebook-based run-length encoding scheme optimized to efficiently compress white space. As most faxes consist mostly of white space, this minimizes the transmission time of most faxes.

MMR

Modified Modified READ (MMR) is a compression method recommended by ITU-T T.6.

Modem

A device that modulates a carrier signal to encode digital information, and also demodulates such a carrier signal to decode transmitted information.

MR

Modified Read (MR) is a compression method recommended by ITU-T T.4. MR encodes the first scanned line using MH. The next line is compared to the first, the differences determined, and then the differences are encoded and transmitted.

Glossary

NetWare

A network operating system developed by Novell, Inc. It initially used cooperative multitasking to run various services on a PC, and the network protocols were based on the archetypal Xerox XNS stack. Today NetWare supports TCP/IP as well as IPX/SPX.

OPC

Organic Photo Conductor (OPC) is a mechanism that makes a virtual image for print using a laser beam emitted from a laser printer, and it is usually green or rust colored and has a cylinder shape.

An imaging unit containing a drum slowly wears the drum surface by its usage in the printer, and it should be replaced appropriately since it gets worn from contact with the cartridge development brush, cleaning mechanism, and paper.

Originals

The first example of something, such as a document, photograph or text, etc, which is copied, reproduced or translated to produce others, but which is not itself copied or derived from something else.

OSI

Open Systems Interconnection (OSI) is a model developed by the International Organization for Standardization (ISO) for communications. OSI offers a standard, modular approach to network design that divides the required set of complex functions into manageable, self-contained, functional layers. The layers are, from top to bottom, Application, Presentation, Session, Transport, Network, Data Link and Physical.

PABX

A private automatic branch exchange (PABX) is an automatic telephone switching system within a private enterprise.

PCL

Printer Command Language (PCL) is a Page Description Language (PDL) developed by HP as a printer protocol and has become an industry standard. Originally developed for early inkjet printers, PCL has been released in varying levels for thermal, dot matrix printer, and laser printers.

PDF

Portable Document Format (PDF) is a proprietary file format developed by Adobe Systems for representing two dimensional documents in a device independent and resolution independent format.

PostScript

PostScript (PS) is a page description language and programming language used primarily in the electronic and desktop publishing areas. - that is run in an interpreter to generate an image.

Printer Driver

A program used to send commands and transfer data from the computer to the printer.

Print Media

The media like paper, labels, and transparencies which can be used in a printer, a scanner, a fax or, a copier.

PPM

Pages Per Minute (PPM) is a method of measurement for determining how fast a printer works, meaning the number of pages a printer can produce in one minute.

PRN file

An interface for a device driver, this allows software to interact with the device driver using standard input/output system calls, which simplifies many tasks.

Protocol

A convention or standard that controls or enables the connection, communication, and data transfer between two computing endpoints.

PS

See PostScript.

PSTN

The Public-Switched Telephone Network (PSTN) is the network of the world's public circuit-switched telephone networks which, on industrial premises, is usually routed through the switchboard.

RADIUS

Remote Authentication Dial In User Service (RADIUS) is a protocol for remote user authentication and accounting. RADIUS enables centralized management of authentication data such as usernames and passwords using an AAA (authentication, authorization, and accounting) concept to manage network access.

Resolution

The sharpness of an image, measured in Dots Per Inch (DPI). The higher the dpi, the greater the resolution.

SMB

Server Message Block (SMB) is a network protocol mainly applied to share files, printers, serial ports, and miscellaneous communications between nodes on a network. It also provides an authenticated Inter-process communication mechanism.

SMTP

Simple Mail Transfer Protocol (SMTP) is the standard for e-mail transmissions across the Internet. SMTP is a relatively simple, text-based protocol, where one or more recipients of a message are specified, and then the message text is transferred. It is a client-server protocol, where the client transmits an email message to the server.

SSID

Service Set Identifier (SSID) is a name of a wireless local area network (WLAN). All wireless devices in a WLAN use the same SSID in order to communicate with each other. The SSIDs are case-sensitive and have a maximum length of 32 characters.

Subnet Mask

The subnet mask is used in conjunction with the network address to determine which part of the address is the network address and which part is the host address.

TCP/IP

The Transmission Control Protocol (TCP) and the Internet Protocol (IP); the set of communications protocols that implement the protocol stack on which the Internet and most commercial networks run.

TCR

Transmission Confirmation Report (TCR) provides details of each transmission such as job status, transmission result and number of pages sent. This report can be set to print after each job or only after failed transmissions.

TIFF

Tagged Image File Format (TIFF) is a variable-resolution bitmapped image format. TIFF describes image data that typically come from scanners. TIFF images make use of tags, keywords defining the characteristics of the image that is included in the file. This flexible and platform-independent format can be used for pictures that have been made by various image processing applications.

Toner Cartridge

A kind of bottle or container used in a machine like a printer which contains toner. Toner is a powder used in laser printers and photocopiers, which forms the text and images on the printed paper. Toner can be fused by a combination of heat/pressure from the fuser, causing it to bind to the fibers in the paper.

TWAIN

An industry standard for scanners and software. By using a TWAIN-compliant scanner with a TWAIN-compliant program, a scan can be initiated from within the program. It is an image capture API for Microsoft Windows and Apple Mac operating systems.

UNC Path

Uniform Naming Convention (UNC) is a standard way to access network shares in Window NT and other Microsoft products. The format of a UNC path is:
\\<servername>\<sharename>\<Additional directory>

URL

Uniform Resource Locator (URL) is the global address of documents and resources on the Internet. The first part of the address indicates what protocol to use, the second part specifies the IP address or the domain name where the resource is located.

USB

Universal Serial Bus (USB) is a standard that was developed by the USB Implementers Forum, Inc., to connect computers and peripherals. Unlike the parallel port, USB is designed to concurrently connect a single computer USB port to multiple peripherals.

Watermark

A watermark is a recognizable image or pattern in paper that appears lighter when viewed by transmitted light. Watermarks were first introduced in Bologna, Italy in 1282; they have been used by papermakers to identify their product, and also on postage stamps, currency, and other government documents to discourage counterfeiting.

WEP

Wired Equivalent Privacy (WEP) is a security protocol specified in IEEE 802.11 to provide the same level of security as that of a wired LAN. WEP provides security by encrypting data over radio so that it is protected as it is transmitted from one end point to another.

WIA

Windows Imaging Architecture (WIA) is an imaging architecture that is originally introduced in Windows Me and Windows XP. A scan can be initiated from within these operating systems by using a WIA-compliant scanner.

WPA

Wi-Fi Protected Access (WPA) is a class of systems to secure wireless (Wi-Fi) computer networks, which was created to improve upon the security features of WEP.

WPA-PSK

WPA-PSK (WPA Pre-Shared Key) is special mode of WPA for small business or home users. A shared key, or password, is configured in the wireless access point (WAP) and any wireless laptop or desktop devices. WPA-PSK generates a unique key for each session between a wireless client and the associated WAP for more advanced security.

WPS

The Wi-Fi Protected Setup (WPS) is a standard for establishing a wireless home network. If your wireless access point supports WPS, you can configure the wireless network connection easily without a computer.

XPS

XML Paper Specification (XPS) is a specification for a Page Description Language (PDL) and a new document format, which has benefits for portable document and electronic document, developed by Microsoft. It is an XML-based specification, based on a new print path and a vector-based device-independent document format.

Index

A

AirPrint 132

C

cleaning
 inside 55
 outside 55
cleaning a machine 55
control panel 20
convention 10

E

eco printing 39

F

favorites settings, for printing 38
features 4
 print media feature 70
front view 18

G

general icons 10
glossary 199
google cloud printing 136

J

jam
 clearing paper 60
 tips for avoiding paper jams 59

L

LED
 machine status 64
Linux
 common Linux problems 191
 driver installation for network
 connected 105
 driver installation for USB cable
 connected 95
 driver reinstallation for USB cable
 connected 96
 printer properties 152
 printing 151
 using SetIP 100

loading

 paper in the tray1 29
 special media 33

M

Mac
 common Mac problems 190
 driver installation for network
 connected 105
 driver installation for USB cable
 connected 93
 driver reinstallation for USB cable
 connected 94
 printing 149
 system requirements 74
 using SetIP 100
maintenance parts 44
manual feeder/multi-purpose tray
 using special media 33
Mopria 130

N

network
 driver installation
 Linux 105
 Mac 105
 Windows 102
installing environment 76

Index

introducing network programs	98	output support	70	printing feature	141
IPv6 configuration	107	preprinted paper	35	problem	
SetIP program	99, 100, 119	special media	33	operating system problems	189
wired network setup	99	printer preferences		problems	
wireless network setup	109	Linux	152	paper feeding problems	175
n-up printing		printer status		power problems	176
Mac	149	general information	166	printing problems	177
O		Printing	36	printing quality problems	181
overlay printing		printing		R	
create	147	changing the default print settings	141	rear view	19
delete	148	Linux	151	regulatory information	77
print	148	Mac	149	S	
P		multiple pages on one sheet of paper		safety	
placing a machine		Mac	149	information	11
adjusting the altitude	140	printing a document		symbols	11
Windows		Windows	36	samsung cloud printing	134
print		printing on both sides of paper		samsung printer experience	168
mobile OS	126	Mac	150	Samsung Printer Status	166
mobile print	126	printing to a file	142	service contact numbers	192
print media		setting as a default machine	141	SetIP program	99, 119
card stock	34	special printer features	143	special print features	139
guidelines	27	printing a document		specifications	68
labels	34	Linux	151		
		Mac	149		

Index

print media	70	Unix		WPS (the machine does not have a display screen)	
stop button	21	system requirements	75	PBC	111
supplies		USB cable		PIN	111
available supplies	43	driver installation	23, 25, 93, 95	wireless network	
estimated toner cartridge life	46	driver reinstallation	94, 96	network cable	119
ordering	43	using help	39, 150		
replacing toner cartridge	49				
SyncThru Web Service		W			
general information	161	watermark			
T		create	146		
toner cartridge		delete	146		
estimated life	46	edit	146		
handling instructions	46	Windows			
non-Samsung and refilled	46	common Windows problems	189		
redistributing toner	47	driver installation for network			
replacing the cartridge	49	connected	102		
storing	45	driver installation for USB cable			
tray		connected	23, 25		
adjusting the width and length	28	system requirements	73		
changing the tray size	28	using SetIP	99, 119		
U		wireless			
understanding the status LED	63	WPS			
		disconnecting			
		PBC mode	111		